

**GB**

Operating instructions  
Automatic spray gun KAA 1300

T-Dok-029-GB-Rev.3

**Item number: 200-0201**  
Translation of the original operating instructions

**Krautzberger** 

Thank you for selecting a Krautzberger product.

This product has been manufactured following state-of-the-art manufacturing procedures and extensive quality assurance measures. We promise you a product of the highest quality.

If you have questions, requests or suggestions, please contact us. We are always glad to assist you.

### **Information about the operating manual**

This manual provides important information on how to work with the device safely and efficiently. The manual is part of the device and must always be kept in the immediate proximity of the device so that it is accessible to the personnel at all times.

The personnel must have read and understood this manual before starting any work. Compliance with all specified safety information and instructions is a basic requirement for safe working conditions.

In addition, the local occupational safety regulations and general safety rules apply for the area of application of the device.

Due to optional finishing variants, it is possible that the figures shown in this operating manual deviate from your device.

### **Information about explosion protection**

Many of our competitors have been marking their products with the Ex symbol as a matter of principle for some time now.

At Krautzberger we do not do that.

We engineer and manufacture our products in line with currently applicable directives.

If the labelling on the product is required, it is affixed to the product as the result of the necessary analysis of ignition sources. If no labelling is affixed, the analysis of ignition sources and previous experience with the assessment of the suitability of products for use in a potentially explosive area have shown that the product described in this operating manual does not represent a potential source of ignition, with the exception of an electrostatic charge.

Taking into account the potential equalisation (provided by proper earth connection), the use in an area at risk for explosions is permitted in accordance with the currently valid directives.

# Table of contents

<b>1</b>	<b>Function and identification</b> .....	<b>5</b>
1.1	Function.....	5
1.2	Identification.....	6
<b>2</b>	<b>Using this operating manual</b> .....	<b>7</b>
2.1	Information about the operating manual.....	7
2.2	Symbols in this operating manual.....	7
2.3	Personnel requirements.....	9
2.4	Personal protective equipment.....	9
<b>3</b>	<b>Safety and responsibility</b> .....	<b>12</b>
3.1	Responsibility of the owner.....	12
3.2	Intended use.....	12
3.3	Specification for the operation of a complete machine.....	12
3.4	Predictable misuse.....	12
3.5	General safety instructions.....	13
3.6	Residual risks.....	14
3.7	Course of action in an emergency.....	14
<b>4</b>	<b>Transport, storage, and packaging</b> .....	<b>15</b>
4.1	Transport.....	15
4.2	Storage.....	15
4.3	Packaging.....	15
<b>5</b>	<b>Menu</b> .....	<b>16</b>
<b>6</b>	<b>Installation</b> .....	<b>17</b>
6.1	Safety.....	17
6.2	General installation information.....	18
6.3	Installing the automatic spray gun.....	19
6.4	Connection scheme.....	20
6.5	Connecting the automatic spray gun.....	21
6.6	Setting of nozzle.....	22
<b>7</b>	<b>Operation</b> .....	<b>23</b>
7.1	Safety.....	23
7.2	General information about initial start-up / commissioning.....	24
7.3	Commissioning.....	25
7.4	Shutting down.....	25
<b>8</b>	<b>Maintenance</b> .....	<b>26</b>
8.1	Safety.....	26
8.2	General information about the maintenance.....	26
8.3	Maintenance schedule.....	27

8.4	Cleaning.....	28
8.5	Checking the channel for material leak.....	29
8.6	Changing the valve needle.....	30
8.7	Change valve seat screw and material nozzle.....	32
8.8	Changing the valve needle pack.....	33
8.9	Changing the axial ring seals.....	37
8.10	Changing the valve spring.....	39
<b>9</b>	<b>Troubleshooting.....</b>	<b>40</b>
9.1	Customer Care.....	40
<b>10</b>	<b>Spare parts.....</b>	<b>41</b>
<b>11</b>	<b>Accessories.....</b>	<b>42</b>
<b>12</b>	<b>Disassembly and disposal.....</b>	<b>43</b>
12.1	Safety.....	43
12.2	Disassembly.....	43
12.3	Disposal.....	43
<b>13</b>	<b>Technical data.....</b>	<b>44</b>
13.1	Dimensions and weight.....	44
13.2	General specifications.....	44
13.3	Dimensions.....	45
<b>14</b>	<b>Declaration of incorporation.....</b>	<b>46</b>
<b>15</b>	<b>Notes.....</b>	<b>47</b>
<b>16</b>	<b>Index.....</b>	<b>50</b>

# 1 Function and identification

## 1.1 Function

The **KAA 1300** automatic spray gun serves the purpose of automatic (non-manual) coating of surfaces like metal, plastic, ceramic, wood, as well as other suitable surfaces.

Typical coating materials include paints, dyes, water-soluble paints, adhesives, anti-adhesives etc. Abrasive materials can also be processed with a working pressure below 5 MPa (50 bar). The automatic spray gun operates based on the airless principle, which means the spray jet is exclusively generated by the material pressure, which presses the material through a nozzle. A pump supplies the material with a maximum pressure of 2.5 MPa (250 bar) through a hose, which is designed for a respective pressure charge, leading to the material connection of the automatic spray gun. Compressed air is added to the control air connection to control the spray process. The air flowing into the air chamber completely moves the piston and thereby the valve needle backwards against the pressure of the spring. This provides access to the front opening of the valves seat screw and under high pressure the material flows into the material nozzle. Here, it exits as a flat, broad material jet and meets the workpiece that needs to be coated.

After exiting the nozzle, the spray jet takes the shape specified by the nozzle. It is directed towards the workpiece. The effective spray jet is not quite as wide as theoretically possible.

The particles of the spray jet reach far higher speeds than with spray guns driven by compressed air. The material flow rate is respectively higher and the jet is sharper, which means the turbulence zone is smaller. The volume and shape of the jet can only be modified by changing the nozzle. The diameter of the nozzle bore determines the material flow volume, while the size and geometry of the elliptically shaped nozzle opening determine the height and width of the jet (shape of an elliptical cone). A large number of airless nozzles are available. They can only be purchased from Krautzberger GmbH.



The nozzle can be seamlessly turned in the axis of the spray jet by 360° and locked into place in any position. This allows an optimal adjustment of the angle with which the jet hits the workpiece to the respective conditions.

Coating materials approved for spray applications by the coating material manufacturer may be used and Krautzberger GmbH offers special designs for materials dissolved in chlorinated hydrocarbon containing solvents as well as abrasive or corrosive materials.

The automatic spray gun can be operated both as an individual device as well as in a larger system together with other spray guns (e.g. as a component of a fully-automatic coating system as well as a spray robot).

The use is particularly suitable where comparatively large volumes of material need to be processed per unit of time. Compared to spray guns driven by compressed air, an additional advantage is that there is less spray mist, ensuring that a far greater percentage of the coating material reaches the workpiece.

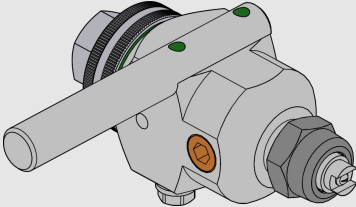
## 1.2 Identification

Scope of delivery	Type	Product number
	<ul style="list-style-type: none"> <li>■ KAA 1300</li> </ul>	200-0201
	Operating manual	T-Dok-029

### Serial number

The serial number of the automatic spray gun is located on the main element. It serves as a unique identifier.

## 2 Using this operating manual

### 2.1 Information about the operating manual

- Knowledge of the fundamental safety instructions and safety regulations is a basic requirement for safe handling and defect-free operation of the product.
- This operating manual contains the most important information about enabling safe operation of the product.
- This operating manual and, in particular, the safety instructions are to be observed by all persons who work on or with the product.
- Furthermore, the rules and regulations for accident prevention in force at the respective operating site are to be observed.

### 2.2 Symbols in this operating manual

#### Safety instructions

This operating manual uses symbols to identify safety instructions. The safety instructions are preceded by signal words that indicate the severity of the hazard.



#### **DANGER!**

This combination of symbol and signal word indicates an immediate dangerous situation, which will cause death or severe injuries if it is not averted.



#### **WARNING!**

This combination of symbol and signal word indicates a potentially dangerous situation which can cause death or severe injuries if it is not averted.



#### **CAUTION!**

This combination of symbol and signal word indicates a potentially dangerous situation which can cause slight injuries if it is not averted.



#### **NOTICE!**

This combination of symbol and signal word indicates a potentially dangerous situation which can cause property and environmental damage if it is not averted.

**ENVIRONMENT!**

This combination of symbol and signal word indicates potential dangers to the environment.

**Tips and recommendations**

*This symbol highlights useful tips and recommendations as well as information for efficient and defect-free operation.*

**Example for safety instructions in operating instructions**

Safety instructions can refer to specific, individual operating instructions. Such safety instructions are embedded in the operating instructions so that they do not disrupt the reading flow when performing the action. The signal words described above are used.

1.  Loosen the screw.

2. 



**CAUTION!****Pinching hazard at the lid!**

Carefully close the lid.

3.  Tighten the screw.

**Special safety instructions**





The following symbols are used in safety instructions to draw attention to specific hazards:

Warning signs	Type of danger
	Warning – hot surface.
	Warning – danger zone.

**Additional markings**

The following markings are used in this manual to highlight operating instructions, outcomes, lists, references, and other elements:



Identification	Explanation
	Step-by-step instructions
	Results of procedural steps
	References to sections in this manual and other applicable documents
	Lists without specified order
[Button]	Operating elements (e.g. buttons, switches), display elements (e.g. signal lights)
'Display'	Screen elements (e.g. pushbuttons, assignment of function keys)

## 2.3 Personnel requirements

This manual identifies the qualifications of the personnel for the different scopes of work as listed below:

### Qualified personnel

Due to their specialised professional training, knowledge, and experience as well as knowledge of the industry-specific standards and regulations, qualified personnel are in a position to perform assigned tasks and to identify and avert potential risks on their own.

### Specialised personnel

Due to their specialised professional training, knowledge, and experience as well as knowledge of the industry-specific standards and regulations, specialised personnel are in a position to perform assigned tasks and to identify and avert potential hazards on their own.

### Trained electrician

Due to specialised professional training, knowledge and experience as well as knowledge of the industry specific standards and regulations, a trained electrician is able to carry out work on the electrical systems and to identified and avert potential risks on his/her own.

The trained electrician has completed specialised training for the specific work environment where he/she works and knows the relevant standards and regulations.

### User

The user is familiar with the basic regulations on occupational safety and accident prevention.

## 2.4 Personal protective equipment

Personal protective equipment is used to protect persons against adverse effects on their health and safety when working.

Personnel must wear personal protective equipment while carrying out the different tasks on and with the machine.

In the course of regular, recurring trainings, the owner should inform operating personnel that working without protective equipment can be detrimental to their health.



*Protective equipment is selected according to the ambient conditions at the owner's premises and the raw materials that are used. The information provided by the material manufacturer on the safety data sheet must be adhered to in order to ensure the proper selection of protective equipment.*

The recommended personal protective equipment is described below:

### **Light respiratory protection**



Light respiratory protection is used as protection against hazardous dusts.

### **Protective gloves**



Protective gloves protect hands from friction, abrasion, puncture wounds, or deeper injuries, as well as from contact with hot surfaces.

### **Safety goggles**



Safety goggles are used to protect the eyes from airborne components and splashes of liquid.

**Protective clothing**

Protective clothing are tight fitting work clothes with low tear resistance, with tight sleeves, and without any protruding parts.

**Safety shoes**

Safety shoes protect the feet against crushing, falling parts or slipping on slippery ground.

**Safety helmet**

The helmet protects the head from falling parts and oscillating loads on the one hand, and it can protect it from injuries in cramped situations on the other.

## 3 Safety and responsibility

### 3.1 Responsibility of the owner

#### Owner

The owner is the person, who directly operates the machine for commercial or economical purposes or who allows a third-party to use/apply it and who is responsible for the legal product stewardship for the protection of the user, the personnel or third parties.

#### Owner responsibilities

The machine is used in an industrial environment. The owner of the machine is therefore subject to the obligations as stipulated by the Occupational Health and Safety Act.

In addition to the safety information in this manual, the country-specific safety, accident prevention guidelines and environmental protection regulations, applicable at the site of implementation of the machine must be adhered to.

Furthermore, the owner is responsible for making sure that the machine is always in perfect technical condition. Therefore, the following applies:

- The owner must ensure that the maintenance intervals described in this operating manual are adhered to.
- The owner must have all safety equipment checked regularly for functionality and completeness.

### 3.2 Intended use

The KAA 1300 automatic spray gun serves the purpose of automatic (non-manual) coating of surfaces like metal, plastic, ceramic, wood, as well as other suitable surfaces.

The intended use also includes the compliance with all the information in this operating manual.

### 3.3 Specification for the operation of a complete machine

- Operation without CE-marking is prohibited.
- Prior to its use, the automatic spray gun must be assembled to form a complete machine.
- Only operate the automatic spray gun after proper fastening on a suitable carrier construction.

### 3.4 Predictable misuse

Any use beyond the intended use or any other use constitutes misuse.

- Only carry out installation and commissioning in accordance with the steps described in this operating manual.
- Always observe the applicable country-specific safety, accident prevention, occupational safety, and environmental protection regulations etc. for the area of use for the automatic spray gun.
- Ensure that the utilised hose lines fulfil the requirements with respect to pressure, chemical, and mechanical loads.
- Do not use sharply abrasive, chemically aggressive, very hot or very cold spray media without first consulting and receiving approval from Krautzberger GmbH.
- Adhere to the spray media manufacturer's safety data sheets.
- Only use the manufacturer's OEM parts.
- Only operate the automatic spray gun after proper fastening on a suitable carrier construction.
- Do not hold the automatic spray gun in your hand during operation.

- Only operate the automatic spray gun while adhering to the values specified in (  Chapter 13 'Technical data' on page 44).
- Make sure that the connected compressed air is oil-free and free from solid matter.
- Operate the automatic spray gun with processed, dried compressed air (air quality pursuant to DIN ISO 8573-1: quality class 4).
- Never point the compressed air at living beings.

**No claims of any kind can be asserted due to damage resulting from misuse!**

### 3.5 General safety instructions



#### **WARNING!**

##### **Life threatening risk of injury or property damage through the application of hazardous media!**

The application of hazardous media can lead to death, serious injuries or property damage.

- Ensure the resistance of the machine against the medium that is to be applied.
- Always adhere to the safety data sheet of the medium that is to be applied.



#### **WARNING!**

##### **Sound pressure level**

Depending on the operating conditions, the sound pressure of the device may cause hearing damage.

Take suitable action to reduce the impact of the existing sound pressure level. The owner is responsible for the type and implementation of suitable measures, which may depend on the local conditions.



#### **CAUTION!**

##### **Risk of injury through compressed air!**

Uncontrolled leaks of compressed air can lead to serious injuries!

- Prior to any work on the device, all compressed-air lines must be closed and bled if necessary.



### **Outdoor operation and operation in exterior areas!**

*Use suitable measures to protect the device during the operation from environmental impacts in an exterior area through:*

- *Moisture*
- *UV radiation*
- *Frost, etc.*

## **3.6 Residual risks**

The automatic spray gun made by Krautzberger GmbH has been manufactured based on state-of-the-art technology and recognised technical safety regulations.

Nonetheless, its use can pose a threat to the life or health of users or third parties, damage the automatic spray gun itself or cause other property damage.

- The automatic spray gun must only be used as intended.
- The automatic spray gun may only be operated in a defect-free condition.
- Any faults impacting the safety must be remedied immediately.

## **3.7 Course of action in an emergency**



*In principle, the applicable national, regional and internal company regulations concerning the course of action in case of an emergency must be adhered to and if necessary respective safety measures must be taken on the system owner's side.*

## 4 Transport, storage, and packaging

### 4.1 Transport

- The automatic spray gun is protected by cardboard packaging.
- The cardboard packaging can be reused for storage.

### 4.2 Storage

Store the automatic spray gun under the following conditions:

- Store the automatic spray gun in the original packaging.
- Do not store outside.
- Store in a dry and dust-free environment.
- Keep away from any aggressive media.
- Protect from UV radiation.
- Avoid mechanical shocks.
- Storage temperature: 15 to 40 °C.
- Relative atmospheric humidity: max. 60%.

### 4.3 Packaging

The automatic spray gun is packaged in accordance with the anticipated transport conditions and the packaging needs to protect it against transport damage, corrosion, and other damage.

- Remove packaging material.
- Remove potentially present transport safety restraints.

## 5 Menu

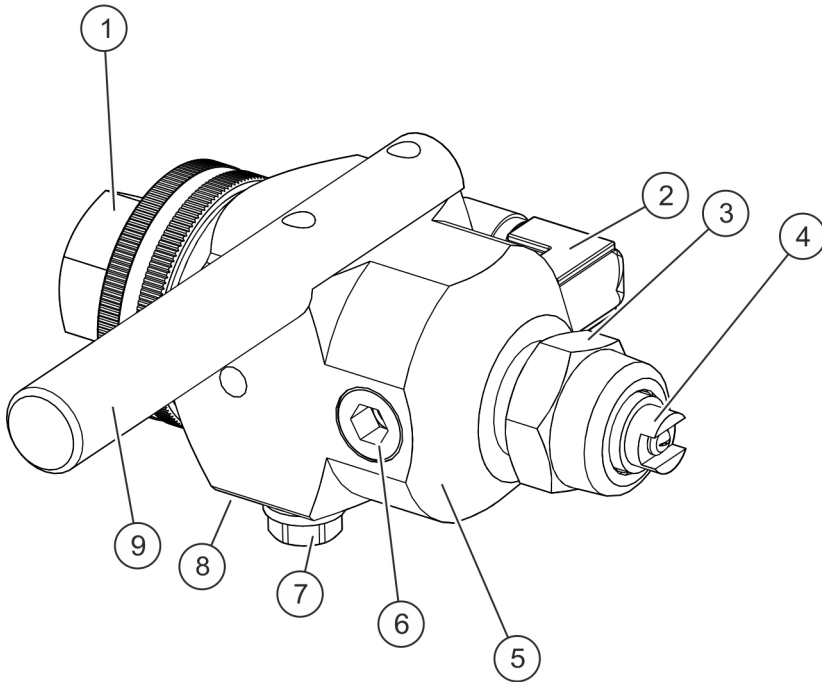

Fig. 1: Menu

- |   |                            |   |  |
|---|----------------------------|---|--|
| 1 | Sealing cap                | 6 | Lock screw (connection for circulation mode) |
| 2 | Connection of fluid supply | 7 | Threaded connection for retaining bolt       |
| 3 | Nozzle nut                 | 8 | Connection for control air                   |
| 4 | Fluid nozzle               | 9 | Retaining bolts                              |
| 5 | Main element               |   |  |



## 6 Installation

### 6.1 Safety

#### Personnel:

- Specialised personnel
- Trained electrician

#### Protective equipment:

The selection of the protective equipment depends on the installation conditions on site. Always observe the applicable country-specific safety, accident prevention, occupational safety, and environmental protection regulations for the proper selection of the protective equipment.



#### **WARNING!**

##### **Risk of injury due to improper installation!**

Improper installation may cause serious personal injury or material damage.

#### Note:

- Ensure ample of space for the installation prior to starting any work.
- Carefully handle open, sharp-edged components.
- Maintain order and cleanliness at the installation site. Components that are loosely stacked or are scattered around can cause accidents.
- Assemble components properly. Adhere to specified screw tightening torque.
- Secure components against tipping or falling.
- Ensure that the utilised hose lines meet the requirements for pressure, chemical and mechanical loads. At the same time, adhere to the spray media manufacturer's specifications in the safety data sheet.



#### **CAUTION!**

##### **Risk of injury through compressed air!**

Uncontrolled leaks of compressed air can lead to serious injuries!

- Prior to any work on the device, all compressed-air lines must be closed and bleed if necessary.

**CAUTION!****Risk of injury due to sharp edges!**

Sharp edges and pointed corners can cause abrasions and cuts on the skin.

Note:

- Proceed cautiously when working on or near sharp edges and pointed corners.
- Wear protective gloves, if in doubt.

## 6.2 General installation information

Adhere to the following general information for installation:

- Only carry out installation and commissioning in accordance with the steps described in this operating manual.
- Ensure that the utilised hose lines fulfil the requirements with respect to pressure, chemical, and mechanical loads.
- Only operate the automatic spray gun after proper fastening on a suitable carrier construction.
- Always guide the hose lines so they cannot be damaged, pinched or rolled over. Avoid excessive tension or bending loads.
- Make sure that the connected compressed air is oil-free and free from solid matter.
- Operate the automatic spray gun with processed, dried compressed air (air quality pursuant to DIN ISO 8573-1: quality class 4).
- Vibration and recoil forces may occur on the automatic spray gun during the operation. Ensure sufficient fastening.
- Never point the compressed air at living beings.
- The pump is designed for the material supply compliance with the values stated in ( [↪ Chapter 13 'Technical data' on page 44](#)).
- A shut-off valve should be connected to the pump in order to be able to quickly disrupt the spray jet in case of a hazardous situation or accident.
- Hose fittings and connections must always be secured so that a sudden forceful movement of the hose ends is prevented in case of an unintended release. If necessary, secure hose ends with clamps.

### 6.3 Installing the automatic spray gun

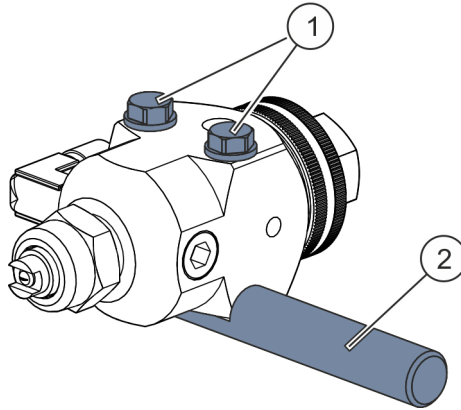

Fig. 2: Installing the automatic spray gun

1. ➤ Install and tighten retaining bolts ( Fig. 2/2) to the automatic spray gun using two screws ( Fig. 2/1).
2. ➤ Fastener retaining bolts ( Fig. 2/2) to the automatic spray gun using a suitable customer provided clamping piece, e.g. a cross, flange or joint clamping piece.
3. ➤ Ensure proper grounding of the automatic spray gun.
4. ➤ Check the tight fit of all threaded connections.

**!** NOTICE!

If the automatic spray gun is not sufficiently fastened, it can come loose during the operation, e.g. due to vibration impact. Risk of shifting, e.g. due to repulsion. It is possible without coating material may exit uncontrollably.

## 6.4 Connection scheme

### Air and material supply

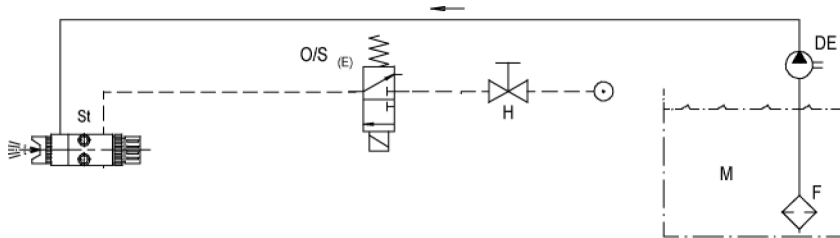

Fig. 3: Air and material supply

- St Control air
- DV Pressure regulator valve
- O/S (E) Opener/closer with bleed
- H Tap
- M Material
- F Filter
- DE Pressure generator
- Material supply
- - - Air supply

## 6.5 Connecting the automatic spray gun

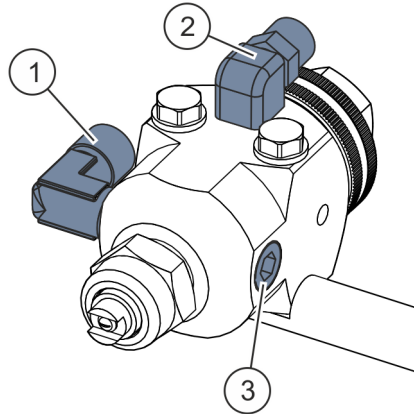

Fig. 4: Connecting the automatic spray gun

1. ➤ Connect the control air to connection for control air ( Fig. 4/2).



*The control air can only execute open and close functions. Dosing of the spray jet via the control air is not possible.*

2. ➤ Connect the material line to the connection of the material supply ( Fig. 4/1).



*If several airless spray guns are fed simultaneously from one high-pressure material source, the closing of the material supply on one or to pull devices may cause repulsion changes at the remaining devices. The repulsion risk may be reduced by using elastic material supply lines, e.g. high-pressure hoses instead of pipes.*

### Circulation operation



*The circulation connection is recommended for example during the processing of settling coating materials or materials for which the temperature must be kept constant.*

3. ➤ Remove lock screw ( Fig. 4/3) and closing plug.
4. ➤ Screw in and tighten the double nipple or connecting bracket.

5.  Connect the material recirculation line and connect with material container.



*If no material circulation is used, one side must be closed with a closing plug and lock screw ( Fig. 4/3).*

## 6.6 Setting of nozzle

The nozzle can be seamlessly turned in the axis of the spray jet by 360° and locked into place in any position.

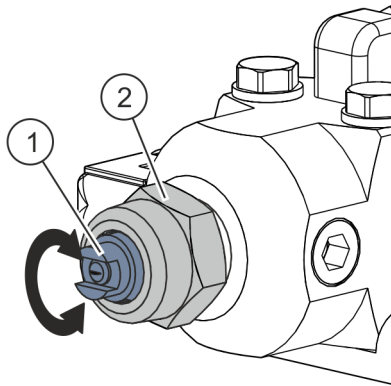





Fig. 5: Nozzle setting

1.  Loosen nozzle nut ( Fig. 5/2); do not unscrew completely.
2.  Turn material nozzle ( Fig. 5/1) to the desired position.
3.  Tighten the nozzle nut ( Fig. 5/2).



### **Adjustment device for SF nozzles and airless nozzles on the automatic spray gun KAA 1300**

*As an option, an adjustment device for SF nozzles and airless nozzles may be used to adjust the nozzles.*

*It can be obtained through Krautzberger GmbH (address on the last page) or via the Krautzberger spare parts catalogue under [www.krautzberger.de](http://www.krautzberger.de).*

## 7 Operation

### 7.1 Safety

#### Personnel:

- User
- Specialised personnel

#### Protective equipment:

The selection of the protective equipment depends on the medium used by the system owner. The information provided by the medium manufacturer indicated on the safety data sheet must be adhered to in order to ensure the proper selection of protective equipment.



#### **WARNING!**

##### **Risk of injury due to improper operation!**

Improper operation can lead to serious personal injuries or property damage.

#### Note:

- Never point compressed air at people.
- Check the material and compressed air hose lines before each use for damage and tight fit.
- Adhere to the spray media manufacturer's specifications in the safety data sheet.
- Make sure that the connected compressed air is oil-free and free of solid matter.



#### **WARNING!**

##### **Risk of death, risk of injury or property damage due to hazardous media!**

Potential consequences: The application of hazardous media can lead to death, severe injuries or property damage.

When handling hazardous substances, ensure that the current safety data sheets of the hazardous substance manufacturer are available. The necessary measures can be derived from the content of the safety data sheet. Since the hazardous potential of a material can be reassessed at any time due to lessons learned, the safety data sheet must be checked regularly and replaced if necessary.

The system owner is responsible for the presence and the up-to-date status of the safety data sheet and the associated generation of the risk assessment of the effected workstations.

**CAUTION!****Risk of injury through compressed air!**

Uncontrolled leaks of compressed air can lead to serious injuries!

- Prior to any work on the device, all compressed-air lines must be closed and bleed if necessary.

**WARNING!****Risk of injury due to hot surfaces!**

The surfaces of components can become very hot during operation. Direct contact with hot surfaces causes severe skin burns.

- Do not touch hot surfaces during operation, wear protective gloves if necessary.
- Ensure that all surfaces have sufficiently cooled down prior to starting any work.

**WARNING!****Sound pressure level**

Depending on the operating conditions, the sound pressure of the device may cause hearing damage.

Take suitable action to reduce the impact of the existing sound pressure level. The owner is responsible for the type and implementation of suitable measures, which may depend on the local conditions.

## 7.2 General information about initial start-up / commissioning

Adhere to the following general information for initial start-up / commissioning:

- Only carry out the commissioning of the automatic spray gun pursuant to the steps described in this operating manual.
- Check the material line and compressed air hose lines for damage and tight fit before each use.
- Check the automatic spray gun for leaks prior to each recurring commissioning (no uncontrolled air discharge, no uncontrolled material discharge when control air is closed).
- Always observe the applicable country-specific safety, accident prevention, occupational safety, and environmental protection regulations etc. for the area of use for the automatic spray gun.
- The chemical resistance of the materials which we use cannot always be assessed with authority due to the large number of fluids, concentrations, temperatures and impurities used. For this reason, please test the suitability because we cannot offer any guarantees in this regard.
- Adhere to the safety data sheets of the spray media manufacturer.



- Only operate the automatic spray gun while adhering to the values specified in (  Chapter 13 'Technical data' on page 44).
- Only operate the automatic spray gun after proper fastening on a suitable carrier construction.
- Do not hold the automatic spray gun in your hand during operation.
- Never point the compressed air at living beings.
- Adhere to the operating manuals for the respective components.

### 7.3 Commissioning



#### **DANGER!**

#### **Risk of fatal injury due to uncontrolled material this church during the change of the nozzle!**



Even though no material can be discharged from the valve seat screw when the control air is closed, there is a risk of fatal injury for all persons in the area of the system in the event that a control air supply should open unintentionally during the exchange of the nozzle. The material jet exits from the front opening of the valve seat screw with high speed. The jet may penetrate skin, enter the body and forcefully inject air. Risk of a fatal embolism! In addition, there is a risk of poisoning in case of toxic coating or cleaning material!

- Not only close the control air supply but also the material supplied during the changing of the airless nozzles.



*The spray pattern for airless devices can by default not be changed through settings on the nozzle. If a different spray pattern is desired, the airless-nozzle must be exchanged.*

*Furthermore, the spray pattern depends on the viscosity of the coating material. It can be modified through the material pressure. If the optimal application cannot be achieved through material pressure changes, it is recommended to try again with a different material nozzle.*





1.  Rinse the automatic spray gun with cleaning products before initial commissioning.
2.  Open the material supply.
3.  Open the control air feed.
  - ⇒ The coating material is sprayed.

### 7.4 Shutting down

#### 7.4.1 Temporary shut-down

-  End the spray process by switching off the control air (connection "St").

#### 7.4.2 Long-term shut-down

1.  End the spray process by switching off the control air (connection "St").
2.  Close the material supply and switch off the pump if necessary.
3.  If necessary, clean the automatic spray gun (  Chapter 8.4 'Cleaning' on page 28).

## 8 Maintenance

### 8.1 Safety

#### Personnel:

- Specialised personnel

#### Protective equipment:

The selection of the protective equipment depends on the maintenance conditions on site and the medium used by the system owner. The applicable country-specific safety, accident prevention, occupational safety, and environmental protection regulations must be adhered to for the proper selection of the protective equipment and the information given by the spray medium manufacturer on the safety data sheet must be taken into consideration.



#### **WARNING!**

##### **Risk of injury through the use of incorrect spare parts!**

The use of incorrect or defective spare parts can cause hazards for the personnel as well as damage, malfunctions or complete failure.

- Only use OEM parts from Krautzberger or Krautzberger-approved spare parts.
- In case of questions, always contact our Customer Care department.



#### **CAUTION!**

##### **Risk of injury through compressed air!**

Uncontrolled leaks of compressed air can lead to serious injuries!

- Prior to any work on the device, all compressed-air lines must be closed and bleed if necessary.



#### **CAUTION!**

##### **Risk of injury due to sharp edges!**

Sharp edges and pointed corners can cause abrasions and cuts on the skin.

#### Note:

- Proceed cautiously when working on or near sharp edges and pointed corners.
- Wear protective gloves, if in doubt.

### 8.2 General information about the maintenance

Adhere to the following general information for the maintenance:

- Only carry out maintenance of the automatic spray gun pursuant to the steps described in this operating manual.
- Lightly grease gliding components with suitable grease, e.g. art. No. 120-0351 of Krautzberger GmbH.
- Clean the dirty parts, replace non-functioning parts.
- First close the material supply and the supply of control air during all maintenance and repair work as well as when changing the nozzle. It is mandatory to wait until the pressure is released.
- Do not clean material nozzles with hard, sharp-hedged objects. We recommend the Krautzberger brush set to clean the nozzles.

### 8.3 Maintenance schedule

The following sections describe the maintenance work that is required for optimal and defect-free operation of the device. Check wearing parts such as seals, nozzles and needles at regular intervals. The level of wear depends on the abrasiveness of the spray medium used. Escaping air and spray fluid as well as the deterioration of the spray pattern are signs that parts are worn. Contact Krautzberger Customer Care should you have any questions about maintenance work and maintenance intervals.

Interval	Maintenance work	Personnel
before performing any maintenance work	Clean the automatic spray gun ( ↗ Chapter 8.4 'Cleaning' on page 28)	Qualified personnel
regularly	Check the moving parts for free range of motion and relubricate when necessary.	
	Check and, if necessary, please replace connections and wear parts (material nozzle, valve seat screw, seals, etc.). Retighten loose fastening screws.	
	Check the channel for leaks ( ↗ Chapter 8.5 'Checking the channel for material leak' on page 29)	
if needed	Change the valve needle ( ↗ Chapter 8.6 'Changing the valve needle' on page 30)	
	Change the valve seat screw and material nozzle ( ↗ Chapter 8.7 'Change valve seat screw and material nozzle' on page 32)	
	Change the valve needle pack ( ↗ Chapter 8.8 'Changing the valve needle pack' on page 33)	
	Change the axial ring seals ( ↗ Chapter 8.9 'Changing the axial ring seals' on page 37)	
	Change the valve spring ( ↗ Chapter 8.10 'Changing the valve spring' on page 39)	













## 8.4 Cleaning



### WARNING!

#### Risk of injury due to improper cleaning!

- Adhere to the safety data sheets of the cleaning product manufacturer.
- Do not immerse the automatic spray gun entirely in cleaning product.

1.  Interrupt the operation (  *Chapter 7.4 'Shutting down' on page 25*).
2.  Switch off the system and secure it against being switched on again.
3.  Connect cleaning product to fluid input.
4.  Switch on the compressed air supply.
5.  Where applicable, switch on pump or pressure container for detergent.
6.  Start spraying process by switching on the control air.
7.  Spray until the cleaning product runs clear.
8.  Interrupt the supply of cleaning product by switching off the pump or the pressure container.
9.  Blow out cleaning product residue by briefly switching on the control air.
10.  Switch off the compressed air supply and safeguard it against restart.
11.  Clean the outside of the device with a cloth dipped in cleaning product.
12.  Lightly grease sliding parts. We recommend the Krautzberger special grease. See the last page for contact information.

## 8.5 Checking the channel for material leak

A channel runs through the automatic spray gun vertical to the compressed air connection, which may collect material in case of a minor leak.

1. ➤ Disrupt operation and secure the system against a restart ( ↪ Chapter 7.4 'Shutting down' on page 25).

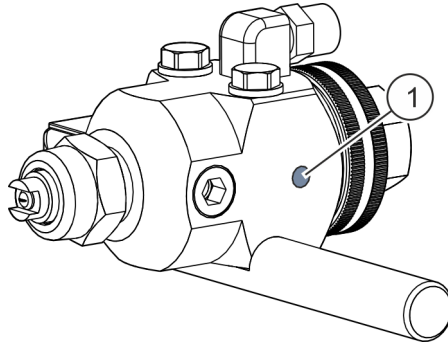

Fig. 6: Channel

2. ➤ Check the channel ( Fig. 6/1) for material leak.
3. ➤ Incapable materially, clearing the trail and replace wear parts (seals, flanges, valve needle, etc.)

## 8.6 Changing the valve needle

### Disassembly

1. ➔ Disrupt operation and secure the automatic spray gun against a restart ( ↪ *Chapter 7.4 'Shutting down' on page 25*).
2. ➔ Clean the automatic spray gun ( ↪ *Chapter 8.4 'Cleaning' on page 28*).

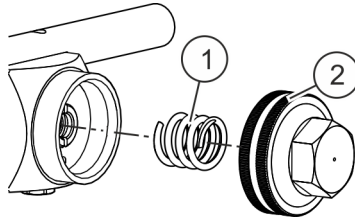

Fig. 7: Unscrewing the sealing cap and removing the pressure spring

3. ➔ Unscrew the sealing cap ( Fig. 7/2).



#### WARNING!

The sealing cap ( Fig. 7/2) is under spring tension.

4. ➔ Remove the pressure spring ( Fig. 7/1).

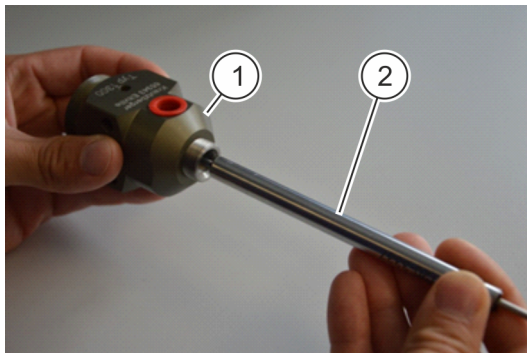

Fig. 8: Pushing out the piston completely

5. ➔ Push piston out of the main element ( Fig. 8/1) using the backside of the assembling tool ( Fig. 8/2).

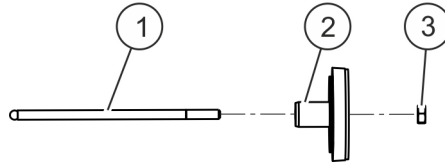

Fig. 9: Replacing the valve needle

6. ➤ Unscrew the nut ( Fig. 9/3) from the valve needle ( Fig. 9/1).

7. ➤



**CAUTION!**

**Risk of injury due to material needles!**

Screw the valve ( Fig. 9/1) needle out of the axis ring ( Fig. 9/2).

**Installation**

8. ➤ Screw the valve needle into the axis ring.

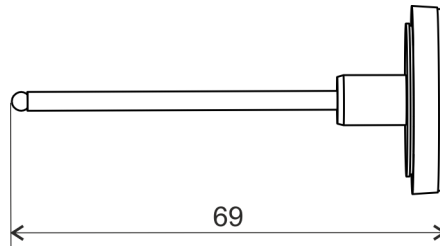

Fig. 10: Adjusting the needle setting dimension

9. ➤ Adjust the needle setting dimension ( Fig. 10).

10. ➤ Retighten the nut.



**NOTICE!**

Glue in the nut with valve needle using Loctite screw adhesive 245.





11. ➤ Re-insert the piston into the main element.

12. ➤ Insert the pressure spring and tighten the sealing cap.

13. ➤ Adhere to general information for commissioning (  Chapter 7.2 'General information about initial start-up / commissioning' on page 24).

## 8.7 Change valve seat screw and material nozzle

### Disassembly

1.  Disrupt operation and secure the automatic spray gun against a restart (  *Chapter 7.4 'Shutting down' on page 25*).
2.  Clean the automatic spray gun (  *Chapter 8.4 'Cleaning' on page 28*).

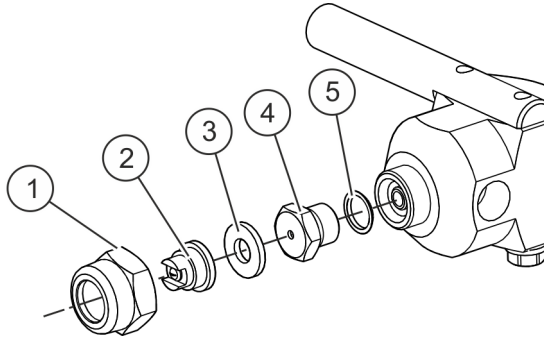





Fig. 11: Valve seat screw and material nozzle

3.  Unscrew the nozzle nut ( Fig. 11/1).
4.  Remove the seal material nozzle ( Fig. 11/2) and seal ( Fig. 11/3).
5.  Completely unscrew the valve seat screw ( Fig. 11/4).
6.  Take out seals ( Fig. 11/5).

### Installation



7. 



#### **WARNING!**

**Risk of injury through the use of incorrect spare parts!**

Insert seal.

8.  Tighten the valve seat screw completely.
9.  Insert seal and material nozzle and tighten nozzle nut.



## 8.8 Changing the valve needle pack

### Disassembly

1. ➔ Dismantle the fluid needle ( ↪ Chapter 8.6 'Changing the valve needle' on page 30).
2. ➔ Dismantle valve seat screw and material nozzle ( ↪ Chapter 8.7 'Change valve seat screw and material nozzle' on page 32).

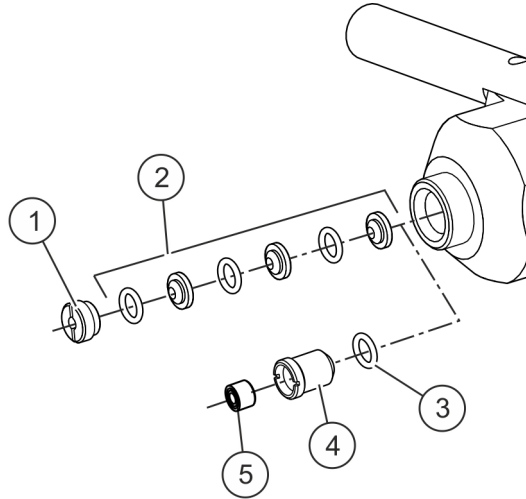

Fig. 12: Valve needle pack

3. ➔ Unscrew the seal screw ( Fig. 12/1) or needle guide ( Fig. 12/4) (depending on design).

### ! NOTICE!

Do not damage the slot for the screwdriver.

4. ➔ Pull out the pack ( Fig. 12/2) or seals ( Fig. 12/3 and 5) (depending on the design).



Use a wire hook to pull out the pack ( Fig. 12/2). Be careful not to damage any threads.

## Installation

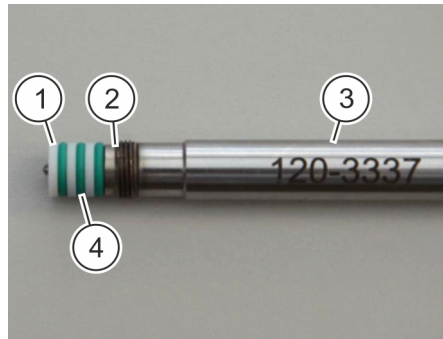

Fig. 13: Sliding the seal pack and seal screw onto the assembly tool

5. 



**WARNING!**

**Risk of injury through the use of incorrect spare parts!**

Slide the seal screw ( Fig. 13/2), seal ( Fig. 13/1) and seal ( Fig. 13/4) onto the assembly tool ( Fig. 13/3).

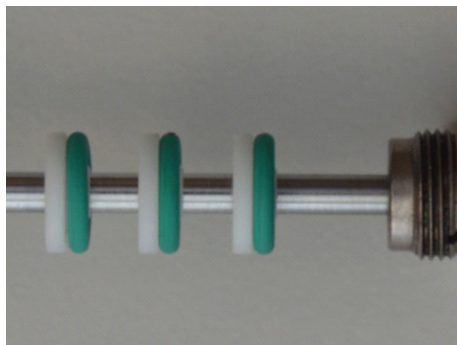

Fig. 14: Detail view

6.  Pay attention to the correct installation position ( Fig. 14).

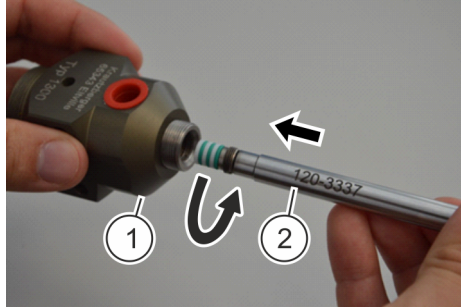

Fig. 15: Assembling the seal pack

7. Carefully slide the seal pack into the main element ( Fig. 15/1) using the assembly tool ( Fig. 15/2). Screw the seal screw into the main element by turning the tool clockwise until you can feel a slight resistance.



#### **Damage to the seal pack**

*If executed improperly, the seal pack may be damaged by the thread of the main body.*

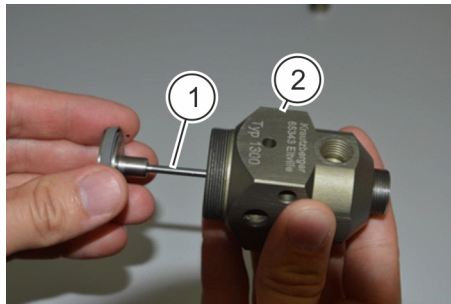

Fig. 16: Assembling the needle piston unit

8. Insert the needle piston unit ( Fig. 16/1) into the main element ( Fig. 16/2) from the piston side and carefully slide it through the seal pack.

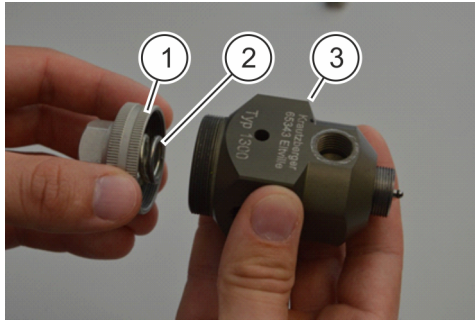

Fig. 17: Assembling the sealing cap and pressure spring



9.  Screw the sealing cap ( Fig. 17/1) and pressure spring ( Fig. 17/2) onto the main element ( Fig. 17/3).



Fig. 18: Tightening the seal screw with torque screw driver

10.  Tighten the seal screw with the torque screw driver ( Fig. 18/1) using the pre-set torque of **1.1 Nm** until the click signal is triggered.



The information contained in the Operation section ( Chapter 7.2 'General information about initial start-up / commissioning' on page 24) must be adhered to after tightening the seal pack.







**Calibration of the torque screw driver**

Recommendation in accordance with DIN EN ISO 6789:

5000 resolutions or one year (tolerance range about 10%).

## 8.9 Changing the axial ring seals

### Disassembly

1.  Dismantle the valve needle (  Chapter 8.6 'Changing the valve needle' on page 30).
2.  Dismantle the valve seat screw and material nozzle (  Chapter 8.7 'Change valve seat screw and material nozzle' on page 32).

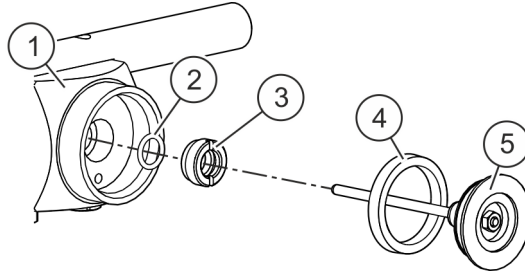





Fig. 19: Axial ring seals

3.  Pull the slotted ring ( Fig. 19/4) from the axial ring ( Fig. 19/5).
4.  Unscrew the threaded ring ( Fig. 19/3) from the main element ( Fig. 19/1).

### NOTICE!

Do not damage the slot for the screwdriver.

5.  Remove the seal ( Fig. 19/2) from the threaded ring ( Fig. 19/3).



Use a wire hook to pull out the seal ( Fig. 19/2). Be careful not to damage any threads.

### Installation

6. 



### WARNING!





**Risk of injury through the use of incorrect spare parts!**

Insert the new seal into the threaded ring.

7.  Tighten the threaded ring.

**!** NOTICE!

Do not damage the slot for the screwdriver.

8.  Place the slotted ring onto the axial ring.
9.  Install the valve seat screw and material nozzle (  *Chapter 8.7 'Change valve seat screw and material nozzle' on page 32*).
10.  Install the valve needle (  *Chapter 8.6 'Changing the valve needle' on page 30*).

## 8.10 Changing the valve spring

The automatic spray gun can be operated with different material pressure, maximum 25 MPa (250 bar). A defect-free sealing between valve needle and valve seat screw can only be achieved when a suitable valve spring is utilized. The available valve springs are colour-coded:

Up to 10 MPa (100 bar) **blue**

Up to 20 MPa (200 bar) **yellow**

Up to 40 MPa (400 bar) **black**.

### Disassembly

1. ➔ Disrupt operation and secure the automatic spray gun against a restart ( ⚠ Chapter 7.4 'Shutting down' on page 25).

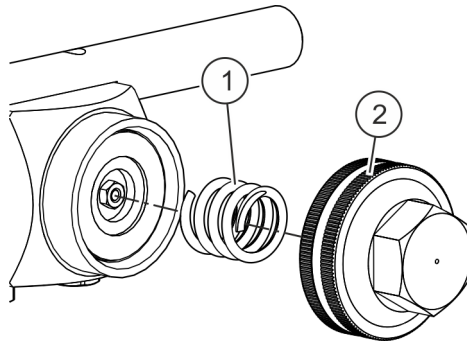

Fig. 20: Valve spring

2. ➔ Unscrew the sealing cap ( Fig. 20/2).



### WARNING!

The sealing cap ( Fig. 20/2) is under spring tension.

3. ➔ Remove the pressure spring ( Fig. 20/1).

### Installation

4. ➔



### WARNING!

Risk of injury through the use of incorrect spare parts!





Insert the pressure spring and tighten the sealing cap.

## 9 Troubleshooting

### Personnel:

- Qualified personnel

In principle, the following applies:

1.  In the event of faults that pose an immediate risk to persons or property values, initiate an emergency stop immediately.
2.  Determine the cause of the fault.
3.  In the event that troubleshooting requires work in the hazard area, switch off the machine and secure it against a restart.
4.  Depending on the type of fault, eliminate the fault or have it eliminated by an authorized specialist.



*Please also check the enclosed supplier documentation for potentially deviating malfunctions or personnel authorizations for eliminating the malfunction.*

*If the fault is not included in the following tables or if it cannot be eliminated with the measures described, contact Krautzberger Customer Care.*

### Troubleshooting table

Error	Cause	Remedy
Unsatisfying spray pattern	Material dirty	Retrofit with filter screen, clean or replacement

### 9.1 Customer Care



*Krautzberger GmbH*

*Customer service*

*Stockbornstr. 13*

*65343 Eltville am Rhein*

*+49 6123 - 698151*

*customer care@krautzberger.com*



## 10 Spare parts



- *Only use OEM parts from Krautzberger or Krautzberger-approved spare parts.*
- *In case of questions, always contact our Customer Care department.*



### **Spare parts order – General**

*To make spare part ordering easier, please provide the following information:*

- *Serial number*
- *Model / product name*
- *Designation*
- *Item number according to spare parts list*
- *Quantity*
- *Desired shipping method (post, freight, sea, air, express)*
- *Delivery address*



*A complete spare part overview is available on the website of Krautzberger GmbH:*

***[www.krautzberger.de](http://www.krautzberger.de)***

## 11 Accessories

A wide range of accessories is available for the automatic spray gun. For further information, visit us on the Internet ([www.krautzberger.com](http://www.krautzberger.com)) or contact your Krautzberger specialist dealer, consultant or our office staff.

## 12 Disassembly and disposal

### 12.1 Safety

#### Personnel:

- Qualified personnel

#### Protective equipment:

The selection of the protective equipment depends on the environmental conditions at the site of the owner and the coating material that is used. To ensure the proper selection of personal protective equipment, the information provided by the spray material manufacturer indicated on the safety data sheet must be adhered to.

### 12.2 Disassembly



#### WARNING!

**Risk of injury due to improper disassembly!**

Prior to starting the disassembly:

- Switch off the device and secure it against a restart.
- Physically disconnect the entire power supply from the device, and discharge any energy stored in the machine.
- Remove and dispose of operating and auxiliary material as well as remaining processing materials in an environmentally friendly manner.

Afterwards, properly clean components and modules and take them apart in compliance with applicable local occupational health & safety regulations as well as environmental protection regulations.

### 12.3 Disposal



#### ENVIRONMENT!

**Danger to the environment due to incorrect disposal!**

Incorrect disposal may cause dangers to the environment.

If no return or disposal agreement has been made, recycle the dismantled parts:

- Scrap metals.
- Recycle plastic components.
- Sort remaining components based on the respective material and dispose of them accordingly.
- Properly dispose of potential spray media residue separately from the device.

If in doubt, obtain information about environmentally-appropriate disposal from the local authorities or specialised disposal companies.

## 13 Technical data

### 13.1 Dimensions and weight

Specification	Value	Unit
Width (without retaining bolts)	40	mm
Height	40	mm
Length	101.5	mm
Weight (without assembly parts)	approx. 300	g

### 13.2 General specifications

#### Operating pressures / Operating temperature

Specification	Value	Unit
Max. material pressure	25 / 250	MPa / bar
max. material temperature	50	°C
Min. Control air pressure	0.4 / 4	MPa / bar
Max. control air pressure	0.8 / 8	MPa / bar
Max. temperature of control air	50	°C

#### Connections

Specification	Value	Unit
Material	G1/4 female	-
Control air	G1/8 female	-

#### Material jet area

Specification	Value	Unit
Angle of material jet in front of nozzle (depending on the nozzle)	up to approx. 110	°
Angle of material jet in front of nozzle (depending on the nozzle and material pressure)	up to approx. 5	m
Length of the material jet when nozzle is screwed off	Up to 20	m

#### Noise

Specification	Value	Unit
Continuous sound pressure level (depends on nozzle)	60 - 90	dB (A)

### 13.3 Dimensions

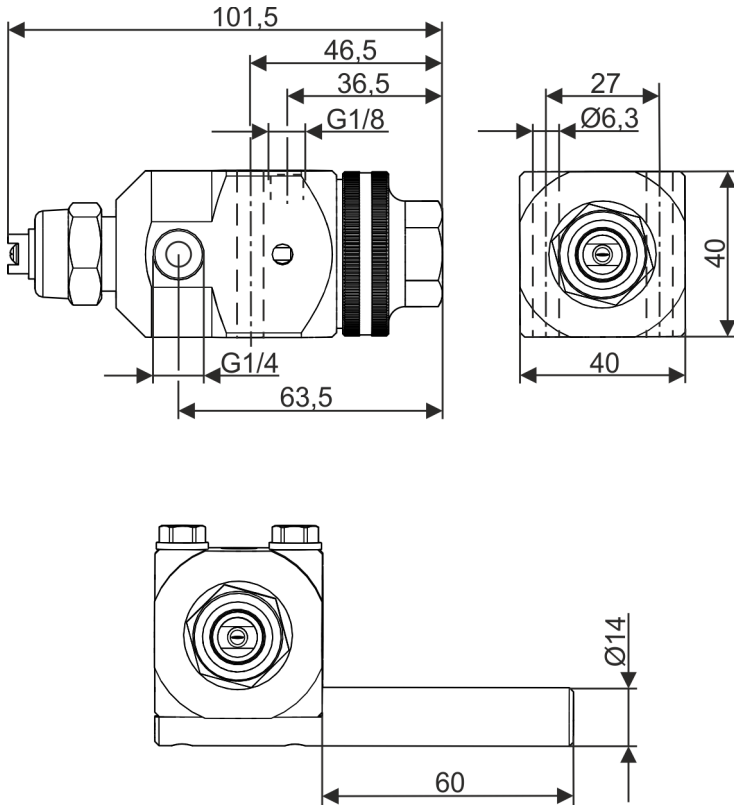



Fig. 21: Dimensions

## 14 Declaration of incorporation

  
**Krautzberger**

**EC-installation explanation by machine guideline in 2006 / 42 / the EC appendix II 1st B**

The manufacturer  
Krautzberger GmbH  
Stockbornstr. 13  
65343 Eltville  
Deutschland

hereby declares, that the following product

Product -/ Project name: Automatic spray gun KAA-1300  
Article number:: 200-0201

to the following basic requirements of the guideline corresponds:  
see appendix "list of the kept requirements after appendix I of the EC-machine guideline in 2006 / 42 / the EC"

The commissioning of this product is prohibited so long, until the machine or the layout in which this product should be installed or from which shows it a component, corresponds to the regulations of all relevant guidelines.

Followers harmonised norms were applied:

EN 1953:2013  
EN ISO 12100:2010  
EN ISO 13732-1:2008

The following national or international norms (or parts / clauses from it) and specifications were applied:  
-

For the product the special technical bases were constructed according to appendix VII shares B, at reasonable desire these bases of a state place can be transmitted by post, e-mail, messenger.

Name and address of the person who is authorised to put together the technical documents

Andreas Lotz  
c/o Krautzberger GmbH  
Stockbornstr. 13  
65343 Eltville  
Deutschland

Place: Eltville am Rhein  
Date: 09.06.2016

  
\_\_\_\_\_  
Jörg Blumrich( Head of Design/Development )

Seite 1 von 1

Fig. 22: Declaration of incorporation









# 16 Index

## C

Cleaning . . . . .	28
Complete machine . . . . .	12
Connection values . . . . .	44
Customer Care . . . . .	40

## D

Delivery . . . . .	15
Dimensions . . . . .	44
Disassembly . . . . .	43

## E

Emissions . . . . .	44
---------------------	----

## H

Health . . . . .	13
------------------	----

## M

Measurements . . . . .	45
Menu . . . . .	16

## N

Noise emission . . . . .	44
--------------------------	----

## O

Operating pressures . . . . .	44
Owner . . . . .	12

## P

Personnel . . . . .	9
Pictograms . . . . .	7

## R

Recycling . . . . .	43
---------------------	----

## S

Sound pressure level . . . . .	44
Storage . . . . .	15
Symbols . . . . .	7

## T

Troubleshooting table . . . . .	40
---------------------------------	----

## U

User qualification . . . . .	9
------------------------------	---

**W**

Weight . . . . . 44



Krautzberger GmbH  
Stockbornstrasse 13  
D-65343 Eltville am Rhein, Germany

Hotline: +49 (0) 6123 698-222  
Head Office: +49 (0) 6123 698-0  
Fax: +49 (0) 6123 698-200  
Email: [mail@krautzberger.com](mailto:mail@krautzberger.com)  
Internet: [www.krautzberger.com](http://www.krautzberger.com)

© Krautzberger GmbH 2019