

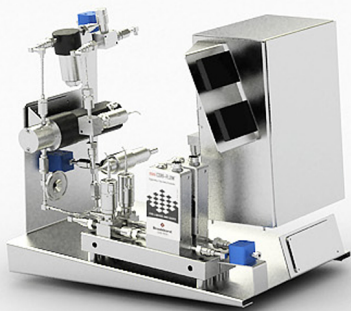

convergence
a definite solution

Procter & Gamble dosing skid version 3 specification



Contents

1	Design Specification Dosing skid 3	4
1	General Functionality	4
2	System Layout	5
2.1	Flowmeters and Gateway	5
2.2	Fieldbus	7
2	PLC reference implementation	8
1	Overview	8
2	Routine description	9
2.1	Settings	9
2.2	Run Mode 0 – Idle	10
2.3	Run Mode 1 – Valve Test	10
2.4	Run Mode 2 – Flushing	11
2.5	Run Mode 3 – Pressure Test	11
2.6	Run mode 4 – Flow Stepping	12
2.7	Run mode 5 – Dosing	13
2.8	Run Mode 6 – Manual	13
3	Critical and non-critical errors	14
3.1	PLC Parameters	15
3	Skid colors, naming & IP Adresses	18
1	Default Test Skid IPs	18
2	Skid IPs	19
4	Reference Implementation HMI Screens	20
5	Bronkhorst Flowmeter parameters & Modbus addresses	22
1	Error Reset	22
2	Labels & Modbus mapping	22
3	Extra information	24
4	Flowmeter M3 and M14 Error Bits	24
5	Flowmeter control modes	24
6	Error Reset	24
7	Read/Write permission	24
6	IEEE-754 standard	25
1	Definition	25
1.1	Conversion of two INTS to REAL according to IEEE-754	25
1.2	Conversion of REAL to two INTS according to IEEE-754	25
7	Rockwell Point I/O connections	26



8 I/O list table Point I/O	27
9 I/O list Modbus Gateway	29
10 Errata	31



Chapter 1

Design Specification Dosing skid 3

1 General Functionality

For accurate dye dosing a compact dosing skid with pumps and flowmeters was designed. A flowrange of 5 - 4500 g/hr of dosing at maximally 10-15 barg is required. The system is equipped with a pump and dual flowmeters to be able to cover the large range in required dosing. Dosing is realized via a direct pump steering (with a bypass).

Multiple dosing skids with different colors will be placed per plant/factory, and are all controlled by the same PLC master. Any combination of color-skids is possible.

The dosing skid will be controlled by a CompactLogix L43 controller using the Ether-Net/IP protocol, which is already installed on all P&G sites. Various modes of control make the dosing skid flexible and allow it to be fitted in multiple P&G plants and allow multiple dosing skids to be used in one location.

The system as currently developed consists of three parts:

- The dosing skid, containing pump and flowmeters.
- A reference implementation on Rockwell Compactlix V17, to test the dosing system standalone and simulate operation.
- Selftest software package (MODBUS RTU), running on PCs and laptops.



(a) 3D model of dosing skid

2 System Layout

The dosing skid is 24VDC powered (M12 panel mount-RED label) and communicates with Ethernet IP over an RJ45 Cat5e cable with the PLC and flowmeters. A Rockwell POint IO module is used to control valves, and read a pressure sensor. Via A Ethernet IP/Modbus RTU gateway the 2 flowmeters can be controlled. The dosing skid has 2 flowmeters that have closed loop control with **one** feed pump. The pump is controlled with 0-10V DC between 0 – 3900 RPM. Because only 1 cable for voltage steering is allowed to the pump (and there are 2 flowmeters), a potential-free relay is used to select which flowmeter has closed loop control with the pump.

The dosing skid has a bypass/pressurize option where flow is recirculated back to the storage vessel. An adjustable needle valve allows to change the bypass flow. The bypass is required for stable low-flow dosing. The system can be controlled in manual and automatic mode. Automatic mode operates fully digitally and makes use of the PID settings that are internally on the flowmeter. Manual allows PID control on the PLC or manual pump steering. The user can in manual mode also pressurize, manually dose and open/close valves and make his own PLC program (using the reference implementation provided by Convergence).

The dosing skid has control over 1 external 'injector valve' and an external pressure sensor. This is a valve outside the skid directly before the point of injection. The pump can only be enabled in either recirculation mode or when the external valve is open. An extra external Normally open valve (pneumatically operated) is used to recirculate the flow back to the feed vessel, just before the injection point.

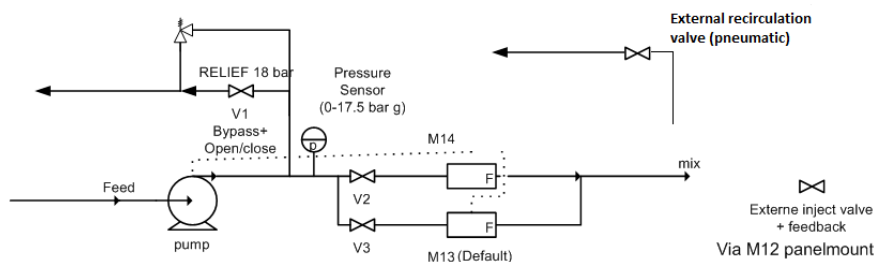

Figure 1.1: Flowsheet for the Dosing Skid

2.1 Flowmeters and Gateway

Flowmeters F1 and F2, as described in figure 1.1 are two Bronkhorst Coriflow flowmeters. Both are connected to the gateway using a RS485 network running at 38400 baudrate, even parity and 1 stopbit using the Modbus RTU protocol. The gateway converts these Modbus packages to EtherNet/IP and visa versa. Flowmeter F1 is node 1 on this network and is a Bronkhorst M13 Coriflow flowmeter, used for low flows flows. Node 2 is a Bronkhorst M14 Coriflow flowmeter, used for high flows. All R/W parameters can be found in Table ??note that **all float values are IEEE-754 format**. All other datatypes are words (16 bit integers) unless specified otherwise.

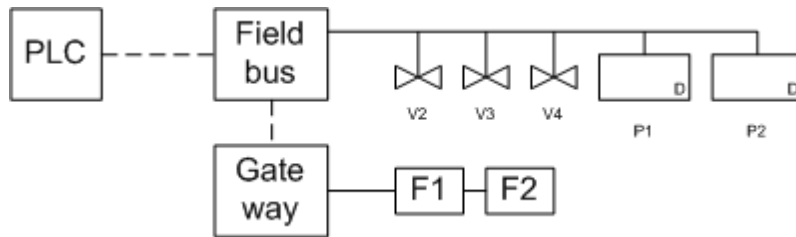

Figure 1.2: Network / Control diagram for the Dosing Skid

The flowmeters use a closed loop to control the pump. Pump steering is done with a 0 - 10VDC signal provided by one of the flowmeters. Only one flowmeter is connected to the pump at the time. A relay on the fieldbus (see table ??) controls which pump is connected to the pump. At any time, only one flowmeter controls the pump. By default, flowmeter F1 has pump control. The flowmeters offer an option to control the pump directly using an external controller by means of a digital interface. See table ?? for more information.

2.2 Fieldbus

All other I/O units are controlled using a Rockwell point I/O fieldbus. These include modules for the relay to switch the selected flowmeter, the pressure sensors and the valves. For a more detailed hardware overview for the fieldbus, see table ??.

The fieldbus is connected as in figure 1.3. See also table 1.1.

Point I/O Modules

Amount	Type	Function
1	1734-AENT:	24V DC ETHERNET ADAPTER
1	1734-IB8	24V DC 8 CHANNEL SINK INPUT MODULE
1	1734-IE4C	24V DC 4 CHANNEL ANALOG CURRENT INPUT MODULE
1	1734-OB8	24V DC 8 CHANNEL STANDARD SOURCE OUTPUT MODULE
1	1734-OW2	24 VDC COIL N.O. DPST RELAY MODULE
5	1734-TOP	TERMINAL ONE PIECE BASE WITH SCREW CLAMP
1	1783-US05T	STRATIX 2000 UNMANAGED ETHERNET SWITCH

Table 1.1: Description of all fieldbus modules

Point I/O Connections

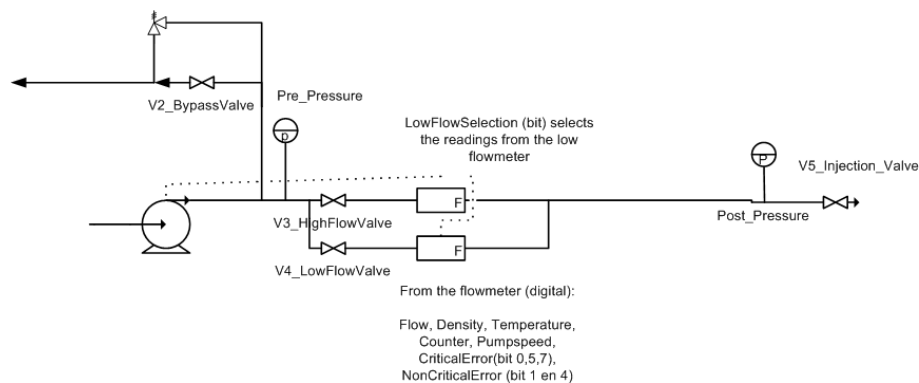

Figure 1.3: Fieldbus overview for the Dosing Skid

For all connections, see Table 7.1.



When multiple dosing skids are used per site, all I/O will have unique tag numbers. Tags listed here are generic tags. See electric drawings for details.

Chapter 2

PLC reference implementation

1 Overview

An example PLC program is provided that features all useful functions for testing and simulation of operation. These functions are implemented as 'run modes':

1. Idle/Reset; resets everything
2. Valve test; opens/closes all valves and checks for feedback
3. Flushing opens all valves and gives pump 100% output for flushing
4. Flow stepping allows automatic scanning of a wide range of flows for stability
5. Pressure test; tests the relief valve pressure
6. Dosing; Runs at a given setpoint
7. Manual control; allows manual valve and pump control



Note that the coriflows have a setpoint alarm at 90 seconds to prevent dry running. This will give a critical error that needs to be reset.

2 Routine description

The most important tag is Set_RUN_MODE, as this decides how the dosing skids functions. Several settings can be changed on how the auto mode behaves.

The runmode selection allows to change different operation modes.

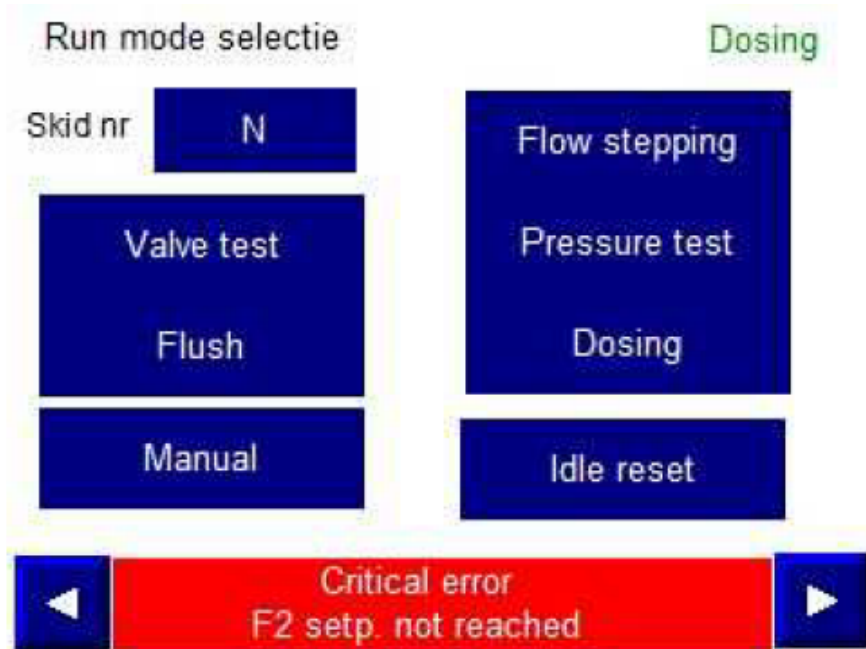

Figure 2.1: Runmode selection

2.1 Settings

Several general settings have effect on multiple modes. In the settings menu these can be adjusted:

- Flow switchpoint; the flowrate in g/hr where the flowcontrol switches from the low-flow meter to the high flowmeter
- Bypass switch-point; The flowrate > than this setpoint (in g/hr) will open the bypass valve
- Reset; clears all errors on the flowmeters and the PLC (such as setpoint alarm on the flowmeter)
- Reboot; reboots the HMI

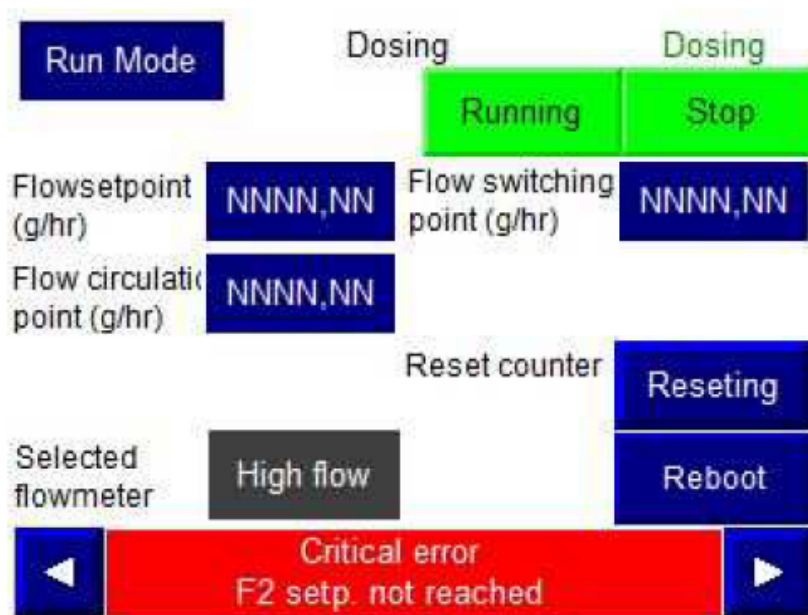

Figure 2.2: Settings menu

2.2 Run Mode 0 – Idle

All valves are closed. The pump is turned off, the flowmeters operate in controlmode 0 with setpoint = 0 g/hr. Any errors are reset.

2.3 Run Mode 1 – Valve Test

The 3 internal valves are opened for a few seconds and then closed. The valves give feedback when in closed position, and no feedback in the open position. If no feedback change is observed a critical error will be given.



The skid controls an external injection valve with both open and closed feedback. If the skid needs to be tested without this valve, click on the simulate button for this valve. Otherwise a critical error will appear.

Valves in the skid per DO number:

1. FV-21X-A (Bypass valve)
2. FV11X-A (Low-flowmeter valve)
3. FV31X-A (High-flowmeter valve)
4. FV31X-B (External dosing valve; 8 pin M12 connection on skid)
5. FV21X (external recirculation valve)

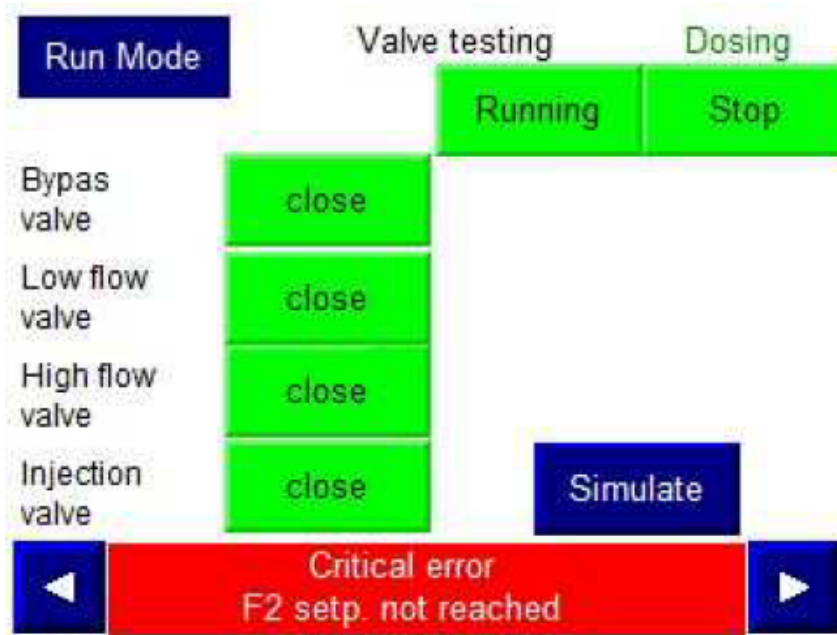

Figure 2.3: Runmode selection

2.4 Run Mode 2 – Flushing

Flowmeter 1 controls the pump in valve steering mode at 100%. PID control is disabled. All valves are opened. The mode runs until the user presses stop.

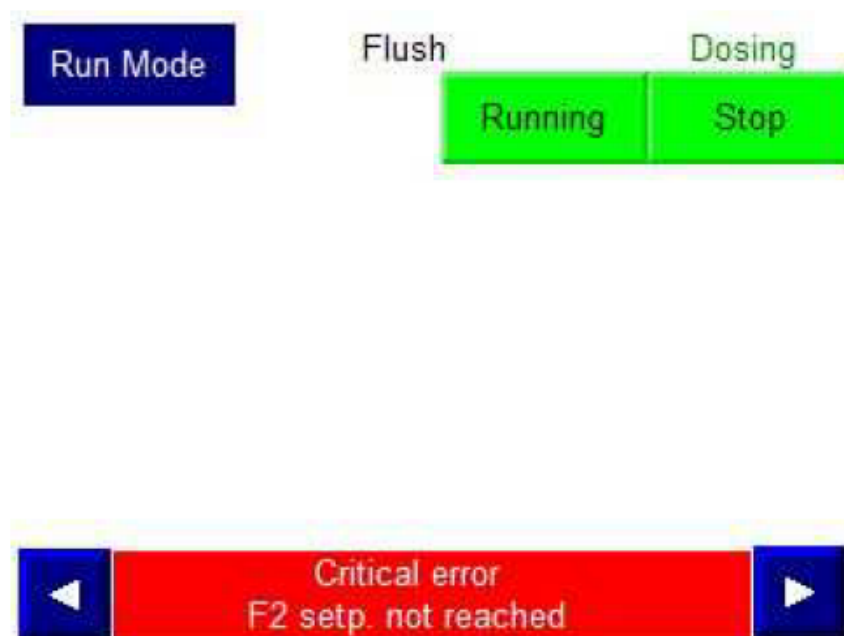

Figure 2.4: Flushing menu

2.5 Run Mode 3 – Pressure Test

The pump runs at the set capacity (0 –100%) with all valves closed. This is to test the maximum pressure, the pressure relief exit will return the water. Only run this mode when

the system has been flushed.

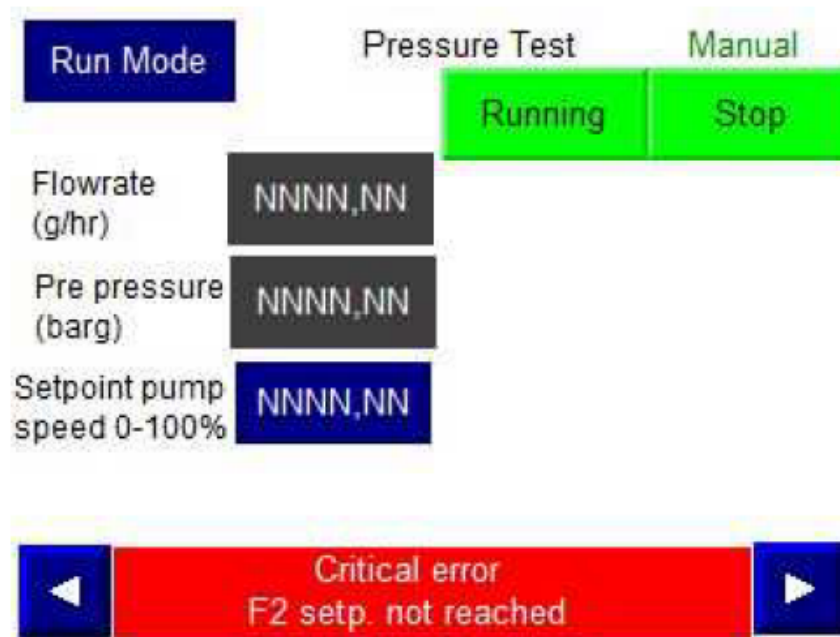

Figure 2.5: Pressure Test menu

2.6 Run mode 4 – Flow Stepping

The user can set steps (and step time) between a minimum and a maximum flow. The system will automatically run all the flowsteps. The switch-point and bypass-setpoint from settings are used. With very high step numbers an approximately linear ramp curve is made. The step-time then determines the slope of the curve.

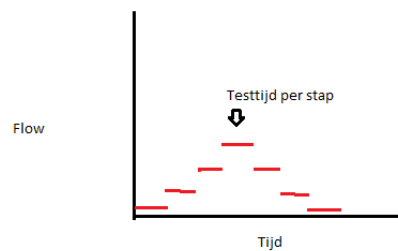

Figure 2.6: Flowstepping

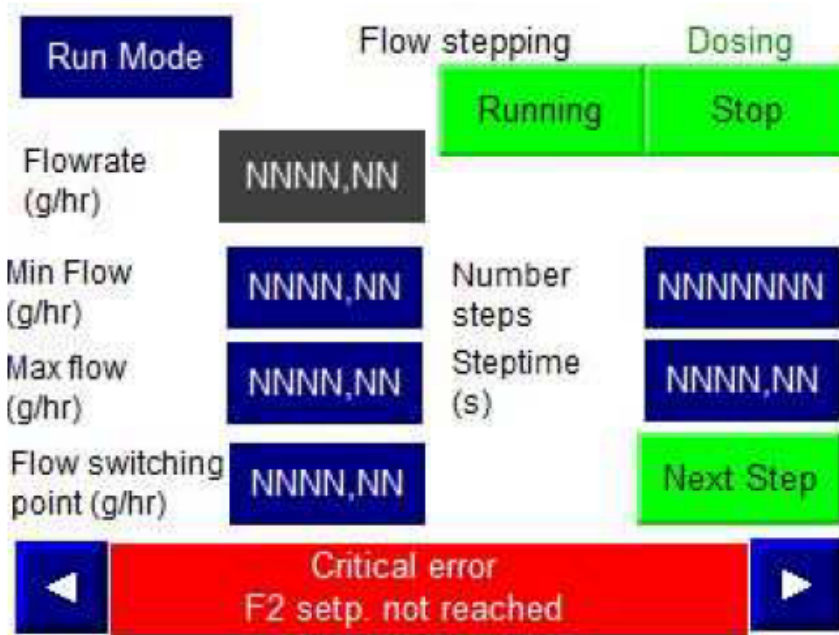

Figure 2.7: Flow-stepping menu

2.7 Run mode 5 – Dosing

Operation at constant setpoint; the entered setpoint is written either to the low-flow or high-flow flowmeter (dependent on switch-point setting). The flowmeter PID controls the pump to the setpoint. All valves are automatically opened.

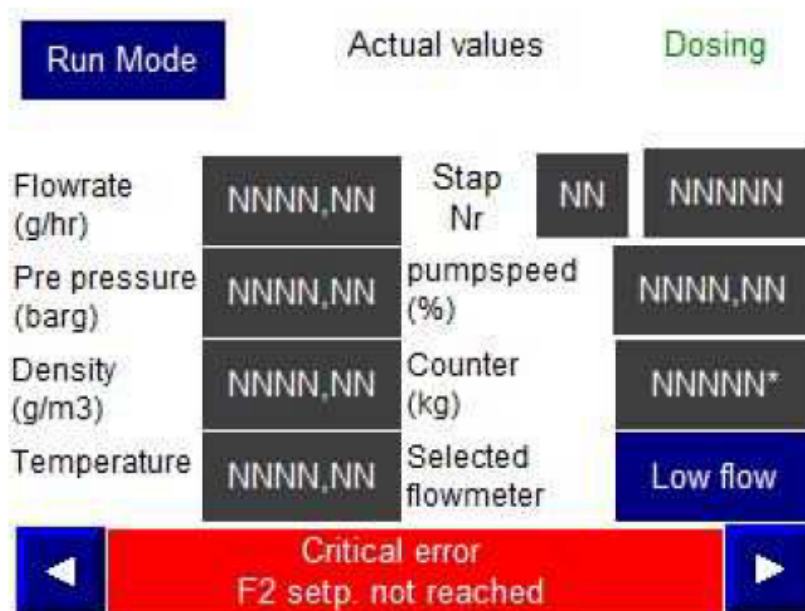

Figure 2.8: Constant dosing setpoint

2.8 Run Mode 6 – Manual

Manual operation of all valves and flowmeters. The user can select which flowmeter to control. PID control is disabled and the pumps are controlled with a direct setpoint (0 –

100%) = (0 – 10V).

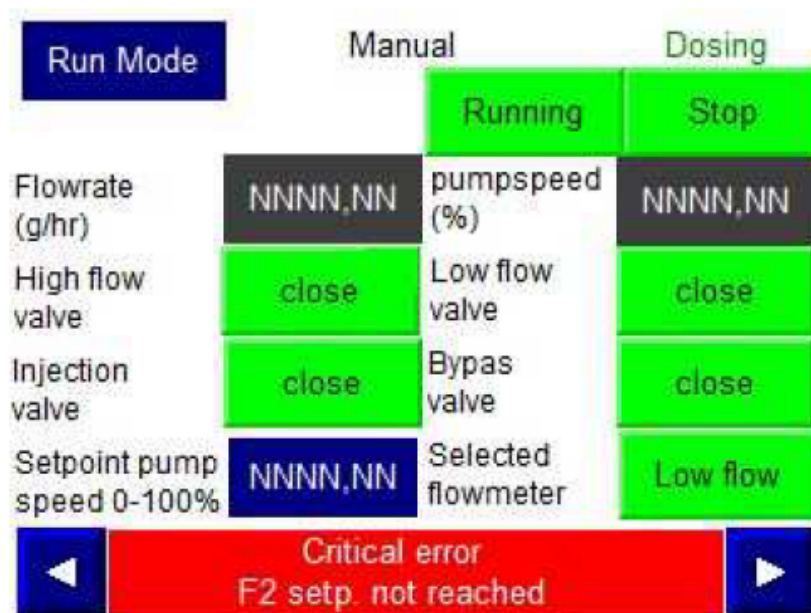

Figure 2.9: Manual control

3 Critical and non-critical errors

Flowmeter errors can be reset by writing numeric value '2' to 'ResetError'. Powering on/off will also reset all errors. Note that on the flowmeters a setpoint alarm has been set, to prevent dry running (at 90 seconds). When the setpoint has not been reached (+/- 5%) within this time the error bit will toggle to TRUE. The flowmeter will stop the pump and not respond to setpoints until the alarm is reset. Direct pump steering (control mode 20) does work when the alarm is triggered).

Error	Use	meaning
Valves (1-4) open-close feedback	Critical	When no open-close feedback is received when the valve is toggled, this is a critical alarm
Flowmeter Instrument error	Critical	Hardware error on device
Communication errors	Critical Alarm	Communication error with point IO or gateway raise critical error
Flowmeter Readout error	Non-critical	vibration problems or instable reading. Usually caused by external vibrations or pump behavior.

Table 2.1: Errors

3.1 PLC Parameters

Name	Usage	DataType	Default	Description
SET_RUN_MODE	Input	INT	0	Run mode 0: Idle Run mode 1: Auto Run mode 2: Manual PID in adOn with sequencer Run mode 3: Manual without sequencer Run mode 4: Flush
FlowSetpoint	Input	REAL	0	Flow setpoint for the controller (in g/hr)
FlowSwitchPoint	Input	REAL	400	Flow switchpoint between the high and low flowmeter. Works in runmode 1 and 2
FlowCirculationPoint	Input	REAL	0	Flow circulation point. Below this point the bypas valve will be opened
PressureSetpoint	Input	REAL	50	Setpoint fore prepressureation works only in runmode 2
PumpPower	Input	REAL	0	Direct control to the pump (in 0-100%)
PumpPowerDirect	Input	BOOL	0	Direct control to the pump without using the flow controllers
V2_BypasValveOpen	Input	BOOL	0	In runmode 3: When high force valve open
V3_HighFlowValveOpen	Input	BOOL	0	In runmode 3: When high force valve open
V4_LowFlowValveOpen	Input	BOOL	0	In runmode 3: When high force valve open
V5_InjectionValveOpen	Input	BOOL	0	In runmode 3: When high force valve open
LowFlowSelection	Input	BOOL	0	In runmode 3: When high force low flowmeter active
RUN_MODE	Output	INT	0	The actual runmode
Flow	Output	REAL	0	The current flow in g/hr
PumpSpeed	Output	REAL	0	The current pump speed in 0-100%
PrePressure	Output	REAL	0	The current pre pressure in barg
PostPressure	Output	REAL	0	The current post pressure in barg
Temperature	Output	REAL	0	The current temerature of the active flowmeter
Counter	Output	REAL	0	Acumulated flow (kg)
Density	Output	REAL	0	The current density in kg/m3
SelectedFlowController	Output	BOOL	0	The active flowmeter. When high the low flowmeter is selected

Table 2.2: Labels available on the PLC.

Name	Usage	Data Type	Default	Description
V2_ByPasValveStatus	Output	INT	0	sHigh: V2 valve [0:Not Activated-1:Not Activated-2:Activated-3:Activated-4>Error]
V3_HighFlowValveStatus	Output	INT	0	High: V4 valve [0:Not Activated-1:Not Activated-2:Activated-3:Activated-4>Error]
V4_LowFlowValveStatus	Output	INT	0	High: V3 valve [0:Not Activated-1:Not Activated-2:Activated-3:Activated-4>Error]
V5_InjectionValveStatus	Output	INT	0	High: V5 valve [0:Not Activated-1:Not Activated-2:Activated-3:Activated-4>Error]
CriticalError	InOut	BOOL		When high a critical error is occurred
NonCriticalError	InOut	BOOL		When high a non critical error is occurred
RecirculateFlow	InOut	BOOL		In runmode 2: when high the flow is recirculated
ResetError	InOut	BOOL		Reset the errors
ResetCounter	InOut	BOOL		Reset the counter of the active flowmeter
GW7472_In	InOut	SINT[50]		Input data from the GW7472 converter
GW7472_Out	InOut	SINT[14]		Output data from the GW7472 converter

Table 2.3: Labels available on the PLC.

Name	Usage	Data Type	Default	Description
V2_Opened		BOOL		High: V2 valve fully opened
V2_Closed		BOOL		High: V2 valve fully closed
V3_Opened		BOOL		High: V3 valve fully opened
V3_Closed		BOOL		High: V3 valve fully closed
V4_Opened		BOOL		High: V4 valve fully opened
V4_Closed		BOOL		High: V4 valve fully closed
V5_Opened		BOOL		High: V5 valve fully opened
V5_Closed		BOOL		High: V5 valve fully closed
P1		INT		Pre Pressure
P2		INT		Post Pressure
F1		INT		HighFlow
F2		INT		LowFlow

Table 2.4: Labels available on the PLC.



Name	Usage	DataType	Default	Description
V2_Control		BOOL		High: Control V2 valve to open
V3_Control		BOOL		High: Control V3 valve to open
V4_Control		BOOL		High: Control V4 valve to open
V5_Control		BOOL		High: Control V5 valve to open
Pump_Control		INT		Controlling the pump 0-10000 = 0-100%
HighFlowControl		INT		HighFlowControl
LowFlowControl		INT		LowFlow control
RL1		BOOL		Relay output for switching between F1 and F2

Table 2.5: Labels available on the PLC.



Chapter 3

Skid colors, naming & IP Adresses

Via Bootp the point IO is given a standard IP address. The Modbus Tgw-700 series is configured with static Ip address the same way

1 Default Test Skid IPs

Skid Name	PLC	HMI	I/O IP	Gateway IP
DEFAULT SKID Nr 1	150.0.3.30	150.0.3.31	150.0.3.40	150.0.3.41
DEFAULT SKID Nr 2	150.0.3.30	150.0.3.31	150.0.3.50	150.0.3.51
DEFAULT SKID Nr 3	150.0.3.30	150.0.3.31	150.0.3.60	150.0.3.61
DEFAULT SKID Nr 4	150.0.3.30	150.0.3.31	150.0.3.70	150.0.3.71
DEFAULT SKID Nr 5	150.0.3.30	150.0.3.31	150.0.3.80	150.0.3.81

2 Skid IPs

Skid Name	Color	I/O IP	Gateway IP	Description
DEFAULT	DEFAUL SKID 1	150.0.3.30	150.0.3.21	XXX dye dosing, double flowmeter skid standard IP
PG 321	LIQUITINT SPECIAL 2	150.0.3.30	150.0.3.31	XXX dye dosing, double flowmeter skid standard IP
PG 321	LIQUITINT SPECIAL 3	150.0.3.30	150.0.3.31	XXX dye dosing, double flowmeter skid standard IP
PG 321	LIQUITINT Blue 1	150.0.3.40	150.0.3.41	XXX dye dosing, double flowmeter skid standard IP
PG 317	LIQUITINT Blue 2	150.0.3.50	150.0.3.51	Blue dye dosing skid, double flowmeter standard IP
PG 318	LIQUITINT Yellow 1	150.0.3.60	150.0.3.61	Red dye dosing skid, double flowmeter standard IP
PG 319	LIQUITINT Yellow 2	150.0.3.70	150.0.3.71	Yellow dye dosing, double flowmeter skid standard IP
PG 320	LIQUITINT Red ST	150.0.3.80	150.0.3.81	XXX dye dosing, double flowmeter skid standard IP
PG 321	LIQUITINT Red OR	150.0.3.90	150.0.3.91	XXX dye dosing, double flowmeter skid standard IP
PG 321	LIQUITINT SPECIAL 2	150.0.3.90	150.0.3.91	XXX dye dosing, double flowmeter skid standard IP
PG 321	LIQUITINT Blue 1	150.0.3.40	150.0.3.41	XXX dye dosing, double flowmeter skid standard IP
PG 317	LIQUITINT Blue 2	150.0.3.50	150.0.3.51	Blue dye dosing skid, double flowmeter standard IP
PG 318	LIQUITINT Yellow 1	150.0.3.60	150.0.3.61	Red dye dosing skid, double flowmeter standard IP
PG 319	LIQUITINT Yellow 2	150.0.3.70	150.0.3.71	Yellow dye dosing, double flowmeter skid standard IP
PG 320	LIQUITINT Red ST	150.0.3.80	150.0.3.81	XXX dye dosing, double flowmeter skid standard IP
PG 321	LIQUITINT Red OR	150.0.3.90	150.0.3.91	XXX dye dosing, double flowmeter skid standard IP

Table 3.1: Tags for the standard IP addresses.

Chapter 4

Reference Implementation HMI Screens

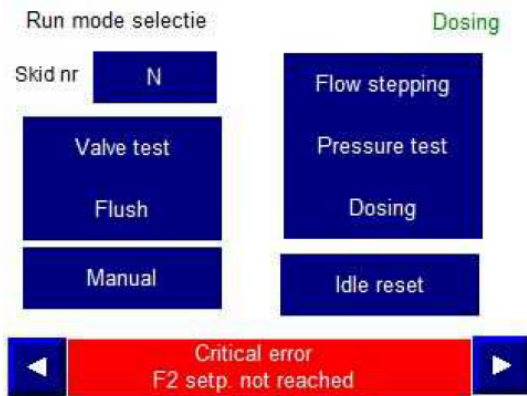

(a) Start screen

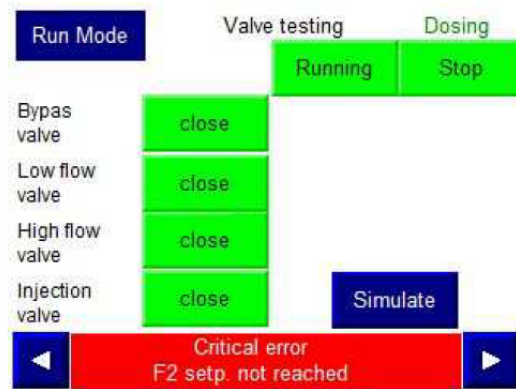

(b) Settings

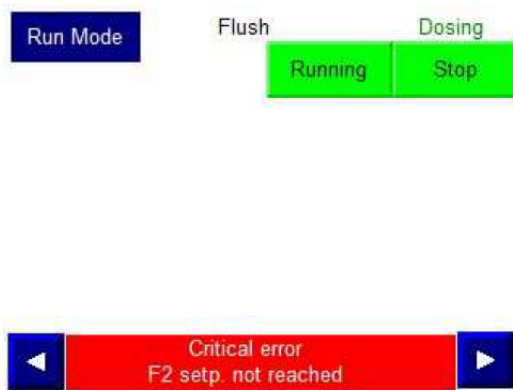

(c) Valve Test

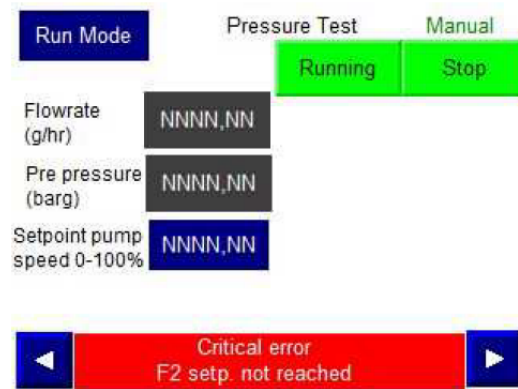

(d) Flush

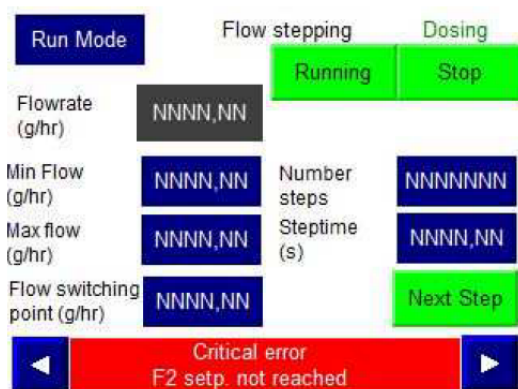

(e) Pressure Test

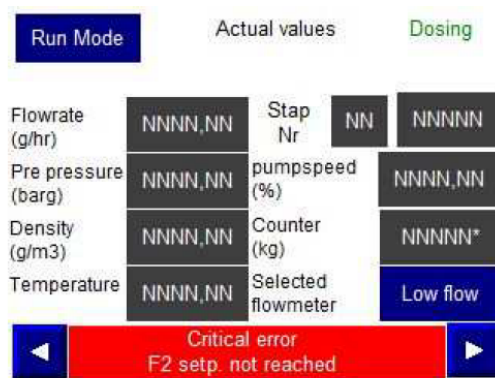

(f) Flow step

Chapter 5

Bronkhorst Flowmeter parameters & Modbus addresses

Detailed information about the Bronkhorst coriolis flowmeters can be found in the manuals 'Operating Manual Digital Instruments'.

Details on modbus can be found in the manual 'Modbus Instruction Manual for MBC'. Both attached separately or available via Bronkhorst website.

1 Error Reset

2 Write numerical value of 2 to reset all errors (also hardware and counter errors)

1 Resets only counter value

2 Labels & Modbus mapping

List of labels with corresponding modbus addresses. These are all configured in the Modbus Gateway and should not be required anywhere.

Label	Funct	Node	Reg	Lngh	Type	RW	comment
<i>Modbus Gateway</i>							
M14READ	4	2	41216	2	float	r	Measured value in g/hr
M13READ	4	1	41216	2	float	r	Measured value in g/hr
M14MAXPOINT	4	2	33128	2	float	r	Maximum capacity from factory, 10 000 g/hr
M13MAXPOINT	4	1	33128	2	float	r	Max capacity from factory, 500 g/hr
M14DENSITY	4	2	62584	2	float	r	measured density in g/l
M13DENSITY	4	1	62584	2	float	r	Measured density in g/l
M14COUNTER	4	2	59400	2	float	r	Counted total mass since reset in kg
M13COUNTER	4	1	59400	2	float	r	COunted total mass since reset
M14TEMP	4	2	41272	2	float	r	Measured temperature in C
M13TEMP	4	1	41272	2	float	r	Measured temperature in C
M14PUMPSPEED	4	2	31	1	word	r	Setpoint as word 0=0% 32000=100%
M13PUMPSPEED	4	1	31	1	word	r	
MINSETPOINT	4	2	33	1	word	w	N/A
MINSETPOINT	4	1	33	1	word	w	Not used
M14INITRESET	4	2	10	1	word	r/w	write value '64'
M13INITRESET	4	1	10	1	word	r/w	write value '64'
M14CONTROMODE	4	2	36	1	word	r/w	write 0 (auto) or 20 (manual)
M13CONTROLMODE	4	1	36	1	word	r/w	write 0 (auto) or 20 (manual)
M14RESET	4	2	3688	1	word	w	write 1 cfor cntr reset
M13RESET	4	1	3688	1	word	w	write 2 for alarm resets
M14ERROR	4	2	52	1	word	r	8 error bits
M13ERROR	4	1	52	1	word	r	

3 Extra information

Bronkhorst M14/M13 coriflow information can be found at the following location. 917023 or on the Bronkhorst website.

Extra information on the remote Rockwell Point IO block: Product specs on the Rockwell website.

Extra information on MDBUS protocol: protocolspecification and de Modbus TCP specificatie op de Modbus website.

4 Flowmeter M3 and M14 Error Bits

The label ERROR_Information contains the following information

bit 0 Instrument Error; critical error

bit 1 Communication error; critical error

bit 2 Min Alarm

bit 3 Max Alarm

bit 4 N/A (counter limit reached)

bit 5 Response Alarm

bit 6 N/A

bit 7 hardwar error critical error

5 Flowmeter control modes

The control modes available on the instrument have the following functions:

mode 0 normal operation, internal PID controls the pump speed based on setpoint

mode 8 pump 100% steering (maximum speed)

mode 20 setpoint (word) directly mapped to pump output signal, no PID.

6 Error Reset

Reset 2 Write numerical value of 2 to reset all errors (also hardware and counter errors)

Reset 3 Resets only counter value

7 Read/Write permission

Control modes cannot be changed (write protection) unless the INITRESET parameter is set to numerical value '64'. See Bronkhorst Modbus manual for explanation.

Chapter 6

IEEE-754 standard

1 Definition

The value of a floating point in the IEEE-754 format is specified by the following equation:

$$value = (-1)^s \cdot 2^{(e-127)} \cdot \left(1 + \frac{1}{m_{mirrored}}\right) \quad (6.1)$$

$$\underbrace{d_7}_s \underbrace{d_6 d_5 d_4 d_3 d_2 d_1 d_0}_{e} \underbrace{c_7 c_6 c_5 c_4 \dots a_2 a_1 a_0}_m \quad (6.2)$$

s : sign

e : exponent

m : mantissa

1.1 Conversion of two INTS to REAL according to IEEE-754

IN: w1 {INT}, w2 {INT}

OUT: f {REAL}

e {INT} := ((w1[14:7]) / 256)

m {DINT} := w1[6:0] * 65536 + w2[15:0]

f {REAL} := (-1)^(w1[15]) * (2 ^ (e - 127)) * (1 + m / 4194304)

1.2 Conversion of REAL to two INTS according to IEEE-754

IN: f {REAL}

OUT: w1{INT}, w2{INT}

w1[15] := (f > 0 ? 0 : 1)

e {INT} := log(abs(f))/log(2) - 127

w1[14:7] := e

m {DINT} := (abs(f)/(2^e) - 1) * 4194304

w1[6:0] := m[31:24]

w2[15:0] := m[23:8]

Chapter 7

Rockwell Point I/O connections



See electrical drawings for exact I/O list and tags. Electrical drawings are always leading. PG IO list table on next pages.

Analog Inputs

ID	Function
AI0	P1 Pressure sensor input (0bar = 4mA, 17.5bar = 20mA)
AI2	SPARE
AI2	SPARE
AI3	SPARE

Digital Inputs

ID	Function
DI0	Feedback bypass valve. High=closed (no feedback on open)
DI1	Feedback low-flow valve (no feedback on open)
DI2	Feedback high-flow valve High=closed (no feedback on open)
DI3	External injection valve feedback for open position
DI4	External injection valve feedback for closed position
DI5	SPARE
DI6	SPARE
DI7	SPARE

Digital Outputs

ID	Function
DO0	Bypass valve
DO1	low-flow valve
DO2	high-flow valve
DO3	Valve 4 (External Injection)
DO4	Pneumatic external recirculation valve.
DO5	SPARE
DO6	SPARE
DO7	SPARE
RL1	Relay for switching between F1 and F2 (Default: F1 connected=M13)
RL2	SPARE

Table 7.1: Description for all fieldbus connections

Chapter 8

I/O list table Point I/O



L&T Integrated Engineering Services



PROJECT:Dosing Skid Point I/O

Document No.

PROJECT	Dosing Skid	CUSTOMER	P&G	Rev No	Date	Prep. by	Checked By	Approved By	Remarks
PHASE		PLANT		01	21-Apr-14	BS	MP	MR	
PO. NO.		MODULE							
		SERVICE							

S.No.	Tag Number	P&ID DWG Number	Service	Associated Equipment/ Line Number	Instrument Description	Skid	PLC I/O Type	Model	Rack No	Card No (coupler=1)	Channel No.	Remarks
0	FV-21X-A	13			Valve open via pneumatic relay		DO	1734-OB8		4	0	Bypass valve
1	FV-11X-A	13			Valve open via pneumatic relay					4	1	Low-flowmeter valve
2	FV-31A-A	13			Valve open via pneumatic relay					4	2	High-flow valve
3	FV-21X-B	13			Valve open					4	3	Injector valve
4	FV-21X	13			Valve open via pneumatic relay		DO			4	4	External recirculation
5	Spare	13								4	5	
5	Spare	13					DO			4	6	
6	Spare	13					DO			4	7	
4	FV-21X-A	12		FV-21X-A	Valve Feedback when closed		DI	1734-IB8		5	0	Bypass valve
5	FV-11X-A	12		FV-11X-A	Valve Feedback when closed	-	DI			5	1	Low-flowmeter valve
6	FV-31A-A	12		FV-31A-A	Valve Feedback when closed	-	DI			5	2	High-flow valve
7	FV-21X-B	12		FV-21X-B	Valve Feedback when closed		DI			5	3	Injector valve
8	FV-21X-B	12		FV-21X-B	Valve Feedback when open		DI			5	4	External recirculation
9		12			Spare		DI			5	5	
10		12			Spare		DI			5	6	
11	FV-21X-B	12		FV-21X-B	Spare	-	DI			5	7	
12	PIT-21X	14		PIT-21X	Pressure transmitter		AI	1734-IE4C		6	0	pre-pressure 0-17.5 bar
13	Spare	14					AI			6	1	
14	Spare	14					AI			6	2	
15	Spare	14					AI			6	3	
16	ZSO-565	15		FV-565	FIC-31X-A/FIC-11-X-A		DO	1734-OX2		7	0	Normally open lowflow (m13)
17	ZSC-565	15					DO			7	1	

Chapter 9

I/O list Modbus Gateway

The data from the converter is returned as an array with all data. All floats are splitted in words according to IEEE-754 standard. The complete array is always returned. See the table below for mapping of the indices. All high modbus addresses are floats. Low addresses always words (e.g. <1000).



L&T Integrated Engineering Services



PROJECT:Dosing Skid Modbus Gateway

Document No.

Modbus Gateway

PROJECT	Dosing Skid	CUSTOMER	P&G	Rev No	Date	Prep. by	Checked By	Approved By	Remarks
PHASE		PLANT		01	21-Apr-14	BS	MP	MR	
PO. NO.		MODULE							
		SERVICE							

S.No.	Tag Number	Example Parameter Name	PLC I/O Type	Length	Description	Skid	R/W	Model	Array Index	NODE	Remarks
0	FIT-11X-A	M13_READ	Float, IEEE-754	2	Low-flowmeter (M13) read value in g/hr		R	Modbus Gateway	0	1	See manual for IEEE-754
1	FIT-11X-A	M13_CAPACITY_MAX	Float, IEEE-754	2	Factory configured fullscale value in g/hr. Default 500 g/hr		R		2	1	Significant byte first for all float
2	FIT-11X-A	M13_DENSITY	Float, IEEE-754	2	Measured density in g/l or kg/m3		R		4	1	M13= LOWFLOW
3	FIT-11X-A	M13_COUNTER	Float, IEEE-754	2	Total flow passed through flow meter after last RESET in kg		R		6	1	
4	FIT-11X-A	M13_TEMPERATURE	Float, IEEE-754	2	Measured temperature in C inside the flowmeter		R		8	1	
5	FIT-11X-A	M13_SETPOINT	Unsigned Integer	1	Setpoint 0 - 32000. 32000 equals 100% or CAP_MAX		R/W		9	1	
5	FIT-11X-A	M13_ERROR_INFO	Unsigned Integer	1	16 error/status bits. Only first 8 are used. See manual for expl.		R		10	1	
6	FIT-11X-A	M13_MIN_CAPACITY	Float, IEEE-754	2	Minimum fullscale capacity, not used		R		12	1	
7	FIT-11X-A	M13_CONTROL_MODE	Unsigned Integer	1	Selection how to control flow. 0=Auto PID, 8=100% 20=manual		R/W		13	1	on cntrl mode 20 direct cntrl
8	FIT-11X-A	M13_RESET	Unsigned Integer	1	Reset errors or counter. 1=reset counter 2=reset all		W	14	1		
9	FIT-31X-A	M13_READ	Float, IEEE-754	2	Low-flowmeter (M13) read value in g/hr		R	Modbus Gateway	16	2	See manual for IEEE-754
10	FIT31X-A	M13_CAPACITY_MAX	Float, IEEE-754	2	Factory configured fullscale value in g/hr. Default 10000 g/hr		R		18	2	Significant byte first for all float
11	FIT31X-A	M13_DENSITY	Float, IEEE-754	2	Measured density in g/l or kg/m3		R		20	2	
12	FIT31X-A	M13_COUNTER	Float, IEEE-754	2	Total flow passed through flow meter after last RESET in kg		R		22	2	
13	FIT31X-A	M13_TEMPERATURE	Float, IEEE-754	2	Measured temperature in C inside the flowmeter		R		24	2	
14	FIT31X-A	M13_SETPOINT	Unsigned Integer	1	Setpoint 0 - 32000. 32000 equals 100% or CAP_MAX		R/W		25	2	
14	FIT31X-A	M13_ERROR_INFO	Unsigned Integer	1	16 error/status bits. Only first 8 are used. See manual for expl.		R		26	2	
15	FIT31X-A	M13_MIN_CAPACITY	Float, IEEE-754	2	Minimum fullscale capacity, not used		R		28	2	
16	FIT31X-A	M13_CONTROL_MODE	Unsigned Integer	1	Selection how to control flow. 0=Auto PID, 8=100% 20=manual		R/W		29	2	on cntrl mode 20 direct cntrl
17	FIT-31X-A	M13_RESET	Unsigned Integer	1	Reset errors or counter. 1=reset counter 2=reset all		W	30	2		

Chapter 10

Errata

- Version 1.0