

Control and Automation

For industrial applications ED.03

Control and signalling units



GE imagination at work

Series P9

E.2 Control and signalling units Ø 22 mm

Series 077

E.42 Control and signalling units Ø 30 mm

Series NLT

E.60 Light towers

E.66 **Foot switches**

E.68 **Safety foot switches**

E.69 **Signalling devices**

Plug-in relays and Auxiliary contactors

Motor protection devices

Contactors and Thermal overload relays

Motorstarters

Control and signalling units

Electronic relays

Limit switches

Speed drive units

Main switches

Numerical index

A

B

C

D

E

F

G

H

I

X

under control



A

B

C

D

E

F

G

H

I

X

- E.3 **Main features**
- E.4 **Range overview**
- E.6 **Technical data**
- E.8 **Order codes - Panel mounting devices**
- E.8 Complete devices
- E.11 Standard push-buttons
- E.11 Mushroom head push-buttons
- E.11 Push buttons with key
- E.12 Selector switches with knob
- E.13 Selector switches with lever
- E.14 Selector switches with key
- E.16 Illuminated push-buttons
- E.16 Illuminated selector switches
- E.17 Selector push-buttons
- E.17 Toggle switches - Joysticks
- E.18 Emergency lever
- E.18 Reset push buttons
- E.18 Potentiometer operators
- E.18 Buzzers - Pilot lights
- E.19 Double function push-buttons
- E.20 Contact blocks
- E.21 Power supplies
- E.22 Electrical diagrams

Control and signalling units

- E.23 **Order codes - Base mounting devices**
- E.23 Contact blocks and power supplies
- E.24 **Order codes - Push-button stations in thermoplastic**
- E.26 **Order codes - Equipped boxes**
- E.28 **Order codes - Push-button stations in aluminium**
- E.30 **Order codes - Common accessories**
- E.36 **Overall dimensions**
- E.36 Panel mounting
- E.41 Enclosures for push-button stations



Main features

Shape, material and colours



The P9 line offers three types of operators:

- round in satin chrome
- round in engineering thermoplastic
- square in engineering thermoplastic

Modern ergonomic P9 actuators are available in a wide variety of colours and styles, and are the result of superior industrial design experience.

Series P9 satisfies any sophisticated industrial applications.

Fitting and positioning

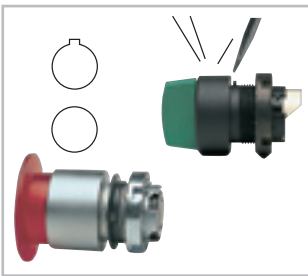

All the P9 operators are fitted with seal to ensure IP66 degree of protection.

A locating tab on the operator allows the correct positioning on panels with holes drilled according to CENELEC EN 50007 standards (with notch). The tab also ensures panel stability and prevents unwanted rotations.

The tab can be removed with a screwdriver for applications in holes without notch.

Rear locking and back mounting procedure



P9 operators are back mounted to the panel by a patented locking ring. The units can be assembled using a standard screwdriver.

As an option, an assembly wrench is available.

Fast mounting

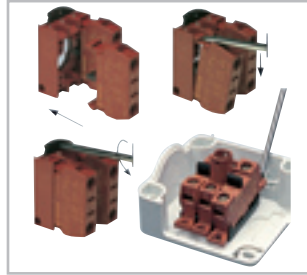

All the P9 rear panel devices are snap-on.

Mounting between panel and operator is accomplished by means of a patented snap-on flange which ensures a fast fitting.

For base mounting, the fitting is done directly on the adaptor inside the enclosure's base.

Each single block can be mounted or removed individually.

In panel mounting, it is also possible to install or remove the snap-on mounting flange with the contact block group;

Blocks and/or flange can be disassembled by a standard screwdriver, to simplify operations.

Safety and reliability



The P9 contact blocks are designed to ensure maximum reliability in every condition and to monitor control circuits at low energy levels

(12V-5mA) minimum), thanks to advanced solution such as:

- four contact points
- high efficiency self-cleaning operation
- silver contacts properly shaped
- high contact pressure

Mounting system

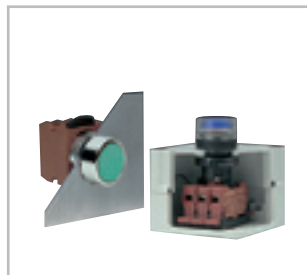

The P9 line offers a wide variety of operators, contact blocks and power supplies for panel mounting.

Furthermore a range of contact blocks and power supplies are available for base mounting.



The base mounting option is simple thanks to plastic enclosures fitted with a standard mounting adaptor, which allows a snap-on and secure fastening.



Panel mounting devices



Control units

<p>Standard push-b.</p>  <p>E.11</p>	<p>Mushroom push-button</p>  <p>E.11</p>	<p>Emergency push-button</p>  <p>E.11</p>	<p>Key push-button</p>  <p>E.11</p>	<p>Knob selector sw.</p>  <p>E.12</p>	<p>Lever selector sw.</p>  <p>E.13</p>
<p>Key selector sw.</p>  <p>E.14</p>	<p>Selector push-b.</p>  <p>E.17</p>	<p>Toggle switch</p>  <p>E.17</p>	<p>Joystick</p>  <p>E.17</p>	<p>Emergency lever</p>  <p>E.18</p>	<p>Double push-b.</p>  <p>E.19</p>

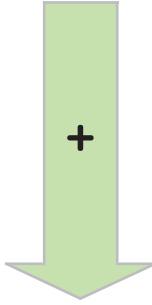

<p>Contact blocks</p>  <p>E.20</p>

A

B

C

D

E

F

G

H

I

X



Illuminated control units Signalling units

Others units

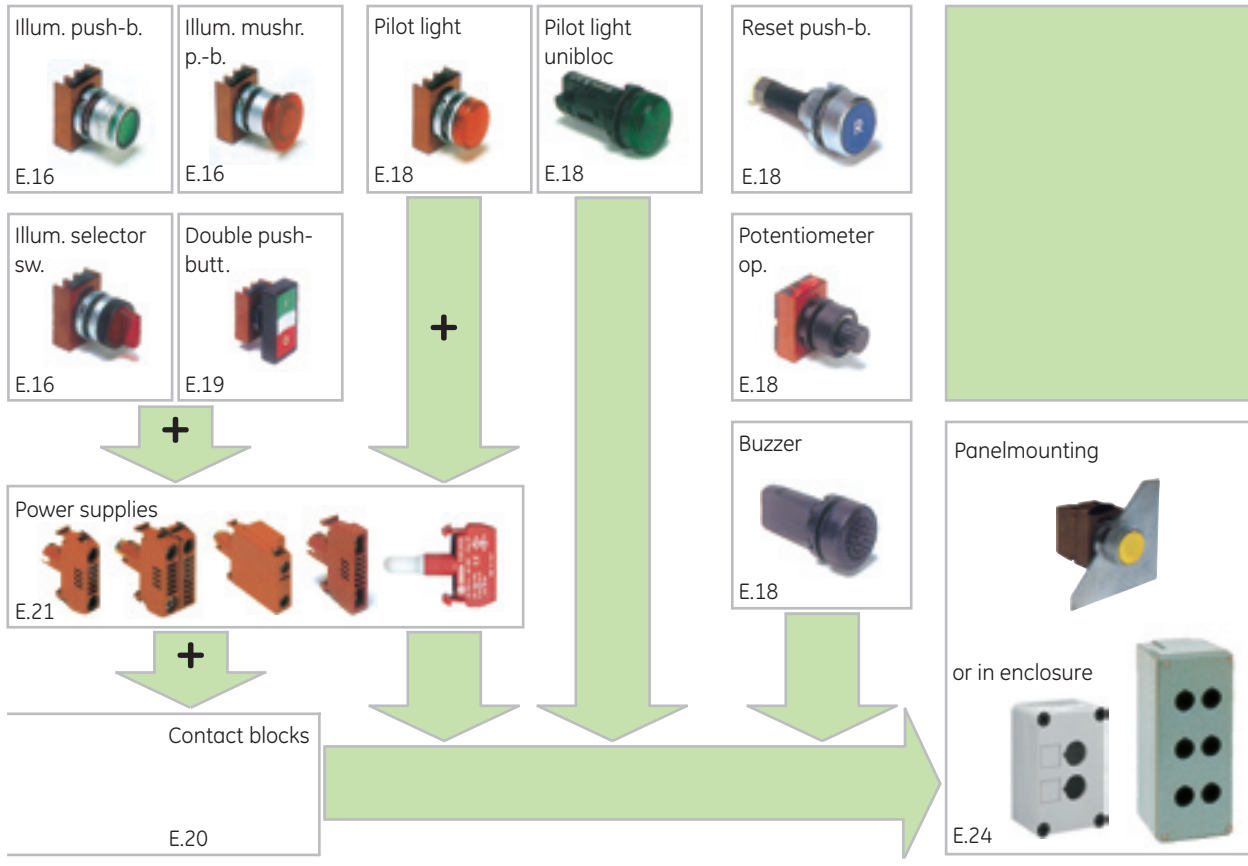

Range overview

- A
- B
- C
- D
- E**
- F
- G
- H
- I
- X

Accessories

General	Push-buttons	Mushroom push-buttons	Selector switches	Illuminated push-buttons	Illuminated mushroom push-buttons	Illuminated selector switches	Pilot lights
Nameplates E.34	Caps E.30	Name plates E.35	Knobs E.32	Diffusers E.31	Lenses E.32	Lenses E.32	Diffusers E.31
Plugs E.33	Rubber caps E.32	Mushr. heads E.32	Lever E.32	Lenses E.32	Collar E.33	Padlock E.33	Lenses E.32
Flanges E.33	Double rubber caps E.19	Collar Ø 40 E.33		Padlock E.33			
Ring wrench E.33	Padlock E.33			Push-on/push-off device E.33			
Neutral plate E.35	Push-on/push-off device E.33			Bulbs BA9S E.34			
	Keys E.34			Bulb extractor E.33			



Technical data

Compliance with standards

IEC 947.5.1 - VDE 0660 - NFC 63140
IEC/EN 60947.5.1 - UTE - BSI - NEMA
CENELEC EN 50007

Approvals

cUL U.S. - RINA - CE - GOST R - Lloyd's Register of Shipping - Bureau Veritas - Germanischer Lloyd

Climatic protections

The standard versions are suitable for use in the following climates:

Temperate climate	cat. 23/50 (DIN 50014)
Wet climate	cat. 23/83 (DIN 50015)
Hot wet climate	cat. 40/92 (DIN 50015)
Variable wet climate	FW24 (DIN 50016)

Temperature ranges

Operation	-25 °C to + 70 °C
Storage	-40 °C to + 70 °C

Protection degree of the operators

IP66 according to CENELEC EN 60529 when they are mounted into enclosures with the same or a higher degree of protection.

Suitable for using into enclosures type NEMA 1-3-3R-3S-4-4X-12-13 according to UL 508.

Protection degree of the terminals

IP2x according to CENELEC EN 60529.

Shock resistance (acc. to MIL 202 B method 202 A)

1/2 sinusoid 11 ms:

No damage or disassembling at 100 g for all devices, except for the illuminated operators with transformer 38 g.

Vibration resistance (according to IEC 68-2-6)

16 g with frequency range from 40 to 500 Hz and maximum shifting 0.75 mm (peak-to-peak).

Rated insulation voltage

690V according to EN 60947.1

Impulse withstand voltage

4 kV according to EN 60947.1

Insulation class

Groep C according VDE 0110

Electrical shocks protection (acc. IEC 536)

Metal operators	Class I
Plastic operators	Class II (double insulation)

Short-circuit protection

With fuses 16A gG according to IEC 269.1 and 269.3.

Performances of the contacts

- Slow acting
- Self-cleaning sliding
- NC forced breaking
- Double movable bridge
- Four switching points
- Double break

Electrical resistance of the contact

≤ 25 m Ω according to IEC 255, cat. 3

Identification of the terminals

According CENELEC EN 50013

Electrical performances

Rated thermal current I_{th} = 10 A

Performances according IEC 947.5.1

Categorie AC 15		24	48	60	110	220	380	500	600
Voltage	U _e (V)	24	48	60	110	220	380	500	600
Current	I _e (A)	10	10	10	6	3	2	1.5	1.2
Categorie DC 13		24	48	60	110	220	300		
Voltage	U _e (V)	24	48	60	110	220	300		
Current	I _e (A)	2.5	1.4	1	0.55	0.27	0.2		

Performances according to CSA and UL

AC Heavy Duty	(A600)
DC Standard Duty	(Q300)

Operating range

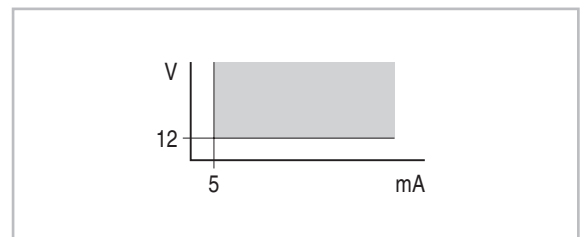

Electrical endurance

Alternative current 50/60 Hz cat. AC 15

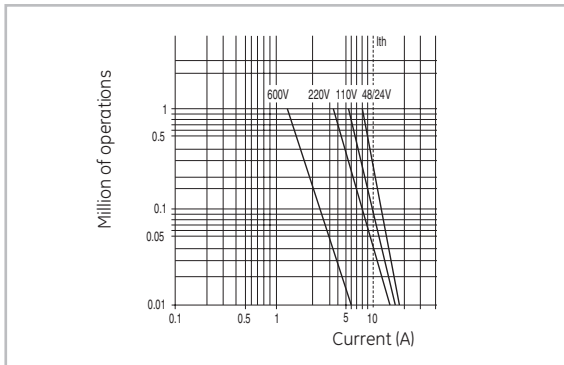

Direct current cat. DC 13

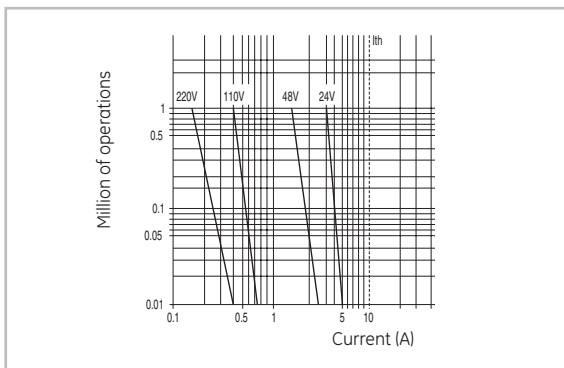

Mechanical endurance

Locking emergency	
Mushroom head push-buttons 3 positions	0.3 Mil./op.
Illuminated mushroom head push-buttons 3 pos.	
Joysticks	
Key push-buttons	
Toggle switches	0.5 Mil./op.
Illuminated selector switches	
Push-on push-off device	
Standard selector switches	
Key selector switches	
Illuminated push-buttons	1 Mil./op
Selector push-buttons	
Emergency lever	
Standard push-buttons	3 Mil./op.
Mushroom head push-buttons	

Rear panel modularity

The P9 series is composed with 10 mm or a multiple of 10 mm modular units, fitted side by side on a proper mounting flange. The standard operators are supplied with a three position flange with a capacity of 3 units of 10 mm or 1 of 10 mm and 1 of 20 mm or 1 of 30 mm.

When the three position flange is not enough to satisfy the applications needs, the five position flange is required to add two more units of 10 mm mounted side by side.

Using the five position flange take into account the bigger with (50 mm instead of 30 mm).

Number of electrical contacts

	Flange	
	standard 3 positions	optional 5 positions
Standard push-buttons		
Mushroom head push-buttons	max 6	max 8
Emergency lever		
Standard selectors	max 4	max 8
Key selector switches		
Joysticks		
Key push-buttons	max 4	-
Selector push-buttons		
Toggle switches		
Mushroom head with lock	max 4	-
Mushroom head push-buttons 3 pos.	max 2	
Illuminated push-buttons		
Illuminated mushroom head push-buttons	max 4	max 4
Illuminated selector switches		
Illuminated mush. push-buttons with lock	max 2	max 2
Illuminated mush. push-buttons 3 pos.		

Mounting

Fitted for panels 1 to 6 mm. thick with holes drilled according to CENELEC EN 50007 standards.

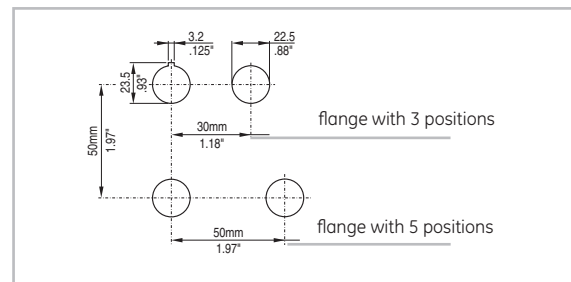

A

B

C

D

E

F

G

H

I

X

Complete devices

Description	Contact-block	Power supply	Cap colour	Cat. no.		Ref. no.	
				Metal	Plastic		
Momentary push-buttons (head + contact block) 	Standard flush	1 NO 	Black	 P9MPN53007	153007	 P9XPN52007	152007
				Green	P9MPN53006	153006	P9XPN52002
	Standard raised	1 NC 	Red	P9MPN53061	153061	P9XPN52061	152061
Mushroom/Emergency push-buttons (head + contact block) 	Mushroom head momentary	1 NC 	Red Ø 40	P9MEM53111	153111	P9XEM52111	152111
	Mush.with latch pull to release	1 NC 	Red Ø 40	P9MET53121	153121	P9XET52121	152121
	Mush.with latch turn to release			P9MER53161	153161	P9XER52161	152161
	Mush.with latch key to release (key 3095)			P9MEC53130	153130	P9XEC52130	152130
Knob selector switch (knob head + contact block) 	2 fixed positions 	1 NO 	Black	P9MSM53293	153293	P9XSM52293	152293
	3 fixed positions 	2 NO 	Black	P9MSM53391	153391	P9XSM52391	152321
Knob selector switch (knob head + contact block) 	2 fixed positions 	1 NO 	Key 3095	P9MSC53435	153435	P9XSC52435	152435
	3 fixed positions 	2 NO 	Key 3095	P9MSC53497	153497	P9XSC52497	152497

A

B

C

D

E

F

G

H

I

X



Complete devices

	Description	Contact-block	Power supply	Cap colour	Cat. no.		Ref. no.	
					Metal	Plastic		
Illuminated push-buttons (Head + Standard full voltage power supply+ contact blocks)	Momentary flush (bulb not included)	1NO		Green	 P9MPL53502	153501	 P9XPL52502	152502
					P9MPL53511	153511	P9XPL52511	152511
					P9MPL53514	153514	P9XPL52514	152514
					P9MPL53515	153515	P9XPL52515	152515
Pilot lights	Standard diffused lens- Full voltage Power supply			Green	P9MLD53610	153610	P9XLD52610	152610
					P9MLD53611	153611	P9XLD52611	152611
					P9MLD53620	153623	P9XLD52620	152620
					P9MLD53621	153621	P9XLD52621	152621
Double functions push-buttons (Head + contact block & power supply when indicated)	Flush both caps	1 NO + 1NC		Green-red			P9DPL54700	154700
					P9DPL54720	154720		
					P9DPL54701	154701		
					P9DPL54721	154721		

Panel mounting

A

B

C

D

E

F

G

H

I

X



Notes

Grid area for notes

A

B

C

D

E

F

G

H

I

X



Push-buttons

Standard / Momentary		Description	Cat. no.		Ref. no.		Cat. no.		Ref. no.	
			see bottom		see bottom		see bottom		see bottom	
			Metal	Plastic	Plastic					
		With flush cap	P9MPN●G	P9XPN●G	P9SPN●G					
		With raised cap	P9MPN●S	P9XPN●S	P9SPN●S					
		Recessed	P9MPN●E							
Mushroom head / Momentary										
		Mushroom head Ø 28 mm	P9MEM3●N	P9XEM3●N*						
		Mushroom head Ø 40 mm	P9MEM4●N	P9XEM4●N*						
		Mushroom head Ø 60 mm	P9MEM6●N							
		Mushroom head ∇ 30 mm					P9SEM3RN		186031	
										* Color N or R
Mushroom head / Emergency with latch										
Standard	Push-pull to release	Mushroom head Ø40 mm	P9MET4●N1	P9XET4●N1			P9SET4R		186061	
	Push-twist to release	Red mushroom head Ø28 mm	P9MER3RN	184070	P9XER3RN	185070				
		Red mushroom head Ø40 mm	P9MER4RN	184071	P9XER4RN	185071				
Positive break in accordance with EN 418	Push-key to release	Red mushroom head Ø40 mm	P9MEC4RN▲		P9XEC4RN▲					
	Push-twist to release	Red mushroom head Ø40 mm			P9XER4RAN	185077	P9SER4RA		186072	
	Push-twist to release	Red mushroom head Ø40 mm with status indication			P9XER4RAW	185078				
	Push-key to release	Red mushroom head Ø40 mm with key code 3095			P9XEC4RA95N	185079	P9SEC4RA95		186073	
Mushroom head / 3 positions										
		Ø40 mm 1-0 fixed. 2 transient	P9MET4●N2							
		Ø40 mm 0 fixed. 1-2 transient	P9MET4●N3							
With keylock ⁽¹⁾										
Key withdrawable in position I & II		normal	P9MPCN1K▲							
		depressed	P9MPCN2K▲							
		normal & depressed	P9MPCN3K▲							
Key withdrawable position III		normal	P9MPCN1E▲							
		depressed	P9MPCN2E▲							
		normal & depressed	P9MPCN3E▲							

(1) Keys on E.14

The catalogue numbers in **bold** are available from stock.

Colours		black	red	green	yellow	brown	blue	white	grey	without cap
Caps	●	N	R	V	G	M	L	B	H	0
Mushroom heads	●	N	R	V	G	-	L	-	-	-

Remark: To complete the catalogue number, substitute the symbol ● by a letter for the choice of the colour and the symbol ▲ by a number for the type of the key.





























For reference numbers, see chapter X, pg. X.8



Panel mounting

- A
- B
- C
- D
- E
- F
- G
- H
- I
- X

Selector switches with knob

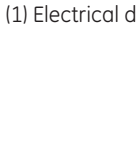
2 positions		Function (1)	Cat. no.	Ref. no. see bottom	Cat. no.	Ref. no. see bottom	Cat. no.	Ref. no. see bottom
Fixed	Metal		Plastic	Plastic				
								
  	Fixed	 D	P9MSMD0●		P9XSMD0N	185110	P9SSMD0N	186110
		 I	P9MSMI0●		P9XSMI0N	185120	P9SSMI0N	186120
	With spring return	 H	P9MSMH0●					
		 D	P9MSMD5●		P9XSMD5N	185150	P9SSMD5N	186140
		 I	P9MSMI5●				P9SSMI5N	186150
		 H	P9MSMH1●					
3 positions		Function (1)	Cat. no.	Ref. no. see bottom	Cat. no.	Ref. no. see bottom	Cat. no.	Ref. no. see bottom
Fixed	E		L	U	Z, B			
								
  	Fixed	E	P9MSME0●				P9SSME0N	186170
		L	P9MSML0●					
	With spring return	U	P9MSMU0●		P9XSMU0N	185190	P9SSMU0N	186190
		Z, B	P9MSMZ0●		P9XSMZ0N	185200	P9SSMZ0N	186200
		E	P9MSME1●				P9SSME1N	186210
		L	P9MSML1●					
U	P9MSMU1●			P9XSMU1N	186230	P9SSMU1N	186230	
Z, B	P9MSMZ1●		P9XSMZ1N	185240	P9SSMZ1N	186240		
 	Fixed	E	P9MSME5●					
		L	P9MSML5●					
	U	P9MSMU5●						
	Z, B	P9MSMZ5●		P9XSMZ5N	185280	P9SSMZ5N	186280	
	Fixed	E	P9MSME3●					
		L	P9MSML3●					
	U	P9MSMU3●						
	Z, B	P9MSMZ3●		P9XSMZ3N	185320	P9SSMZ3N	186320	
4 positions		Function (1)	Cat. no.	Ref. no. see bottom	Cat. no.	Ref. no. see bottom	Cat. no.	Ref. no. see bottom
Fixed	X							
								
 	With spring return	X	P9MSMX0●		P9XSMX0N	185330	P9SSMX0N	186330
		X	P9MSMX5●					
5 positions		Function (1)	Cat. no.	Ref. no. see bottom	Cat. no.	Ref. no. see bottom	Cat. no.	Ref. no. see bottom
Fixed	X		W					
								
 	Fixed	X	P9MSMY0●					
		W	P9MSMW0●					

(1) Electrical diagrams, see E.22































The catalogue numbers **in bold** are available from stock.

Colours round shape	black	red	green	yellow	blue	
Knobs	●	N	R	V	G	L

For reference numbers, see chapter X, pg. X.8



Selector switches with lever

2 positions		Function (1)	Cat. no.	Ref. no. see bottom	Cat. no.	Ref. no. see bottom
			Metal		Plastic	
 	Fixed		D	P9MSVD0		P9XSVD0N 185370
			I	P9MSVI0		P9XaSVI0N 185371
			H	P9MSVH0		
	With spring return		D	P9MSVD5		P9XSVD5N 185373
			I	P9MSVI5		
			H	P9MSVH1		
3 positions						
 	Fixed		E	P9MSVE0		
			L	P9MSVL0		
			U	P9MSVU0		
			Z, B	P9MSVZ0		P9XSVD0N 185379
	With spring return		E	P9MSVE1		
			L	P9MSVL1		
			U	P9MSVU1		
			Z, B	P9MSVZ1		
	With spring return		E	P9MSVE5		
			L	P9MSVL5		
			U	P9MSVU5		
			Z, B	P9MSVZ5		
With spring return		E	P9MSVE3			
		L	P9MSVL3			
		U	P9MSVU3			
		Z, B	P9MSVZ3		P9XSVD3N 185391	
4 positions						
 	Fixed		X	P9MSVX0		P9XSVDX0N 185392
	With spring return		X	P9MSVX5		
5 positions						
Fixed		W	P9MSVW0			
		X	P9MSVX0			

(1) Electrical diagrams, see E.22

The catalogue numbers in **bold** are available from stock.

Colours	●	black	red	green	yellow	blue
Levers	●	N	R	V	G	L











For reference numbers, see chapter X, pg. X.8



Panel mounting

- A
- B
- C
- D
- E**
- F
- G
- H
- I
- X

Selector switches with key

2 positions		Function (1)	Key removal	Cat. no.	Ref. no. see bottom	Cat. no.	Ref. no. see bottom	Cat. no.	Ref. no. see bottom	
Fixed	Metal			Plastic	Plastic (1)					
		D	I	P9MSCD0A▲		P9XSCD0A95	185400	P9SSCD0A95	186400	
			II		P9MSCD0E▲		P9XSCD0E95	185401		
			I-II		P9MSCD0K▲		P9XSCD0K95	185402		
		I	0	P9MSCI0C▲						
			I		P9MSCI0E▲					
			0-I		P9MSCI0N▲					
		H	I	P9MSCH0A▲						
			0		P9MSCH0C▲					
			I-0		P9MSCH0H▲					
	D	I	P9MSCD5A▲		P9XSCD5A95	185409	P9SSCD5A95	186409		
		I	0	P9MSCI5C▲		P9XSCI5C95	185410	P9SSCI5C95	186410	
			H	0	P9MSCH1C▲					
3 positions										
		E	I	P9MSCE0A▲						
			0	P9MSCE0C▲						
			II	P9MSCE0E▲						
			I-0	P9MSCE0H▲						
			I-II	P9MSCE0K▲						
			0-II	P9MSCE0N▲						
		L	I	P9MSCL0A▲						
			0	P9MSCL0C▲						
			II	P9MSCL0E▲						
			I-0	P9MSCL0H▲						
			I-II	P9MSCL0K▲						
			0-II	P9MSCL0N▲						
		U	I	P9MSCU0A▲						
			0	P9MSCU0C▲						
			II	P9MSCU0E▲						
			I-0	P9MSCU0H▲						
			I-II	P9MSCU0K▲						
			0-II	P9MSCU0N▲						
	Z, B	I	P9MSCZ0A▲		P9XSCZ0A95	185433				
		0	P9MSCZ0C▲		P9XSCZ0C95	185434				
		II	P9MSCZ0E▲		P9XSCZ0E95	185435				
		I-0	P9MSCZ0H▲							
		I-II	P9MSCZ0K▲							
		0-II	P9MSCZ0N▲							
	I-0-II	P9MSCZ0T▲		P9XSCZ0T95	185439	P9SSCZ0T95	186439			

(1) Electrical diagrams, see E.22

The catalogue numbers in **bold** are available from stock.

Keys for round metal shape

	Standard version number	▲	95								
	Standard version with specific number	▲	01	02	03	04	05	10	16	19	55 (Ronis)
	FIAT version number	▲	33	34	37	38	40				
Colour		yellow	black	red	blue	orange					

(1) Key for square shape and round plastic shape, only standard version 95

For reference numbers, see chapter X, pg. X.8



Selector switches with key

3 positions		Function (1)	Key removal	Cat. no.	Ref. no. see bottom	Cat. no.	Ref. no. see bottom	Cat. no.	Ref. no. see bottom
	With spring return		E	0	P9MSCE1C▲				
				II	P9MSCE1E▲				
				0-II	P9MSCE1N▲				
		L	0	P9MSCL1C▲					
			II	P9MSCL1E▲					
			0-II	P9MSCL1N▲					
	U	0	P9MSCU1C▲						
		II	P9MSCU1E▲						
		0-II	P9MSCU1N▲						
	Z; B	0	P9MSCZ1C▲						
		II	P9MSCZ1E▲						
		0-II	P9MSCZ1N▲						
		E	I	P9MSCE5A▲					
			0	P9MSCE5C▲					
			I-0	P9MSCE5H▲					
		L	I	P9MSCL5A▲					
			0	P9MSCL5C▲					
			I-0	P9MSCL5H▲					
U	I	P9MSCU5A▲							
	0	P9MSCU5C▲							
	I-0	P9MSCU5H▲							
Z, B	I	P9MSCZ5A▲	P9XSCZ5A95	185461	P9SSCZ5A95	186461			
	0	P9MSCZ5C▲	P9XSCZ5C95	185462					
	I-0	P9MSCZ5H▲	P9XSCZ5H95	185463					
	E L U Z, B		0	P9MSC3C▲					
			0	P9MSL3C▲					
			0	P9MSCU3C▲					
			0	P9MSCZ3C▲	P9XSCZ3C95	185467	P9SSCZ3C95	186467	
4 positions		Fixed		X	I	P9MSCX0A▲			
	II			P9MSCX0B▲					
	III	P9MSCX0D▲							
	IV	P9MSCX0E▲							
	I-II	P9MSCX0F▲							
	I-III	P9MSCX0J▲							
	I-IV	P9MSCX0K▲							
	II-III	P9MSCX0L▲							
	II-IV	P9MSCX0M▲							
	III-IV	P9MSCX0P▲							
	I-II-III	P9MSCX0R▲							
	I-II-IV	P9MSCX0S▲							
	I-III-IV	P9MSCX0U▲							
	II-III-IV	P9MSCX0V▲							
	I-II-III-IV	P9MSCX0Z▲							
With spring return		X	I	P9MSCX5A▲					
		II	P9MSCX5B▲						
		III	P9MSCX5D▲						
		I-II	P9MSCX5F▲						
		I-III	P9MSCX5J▲						
		II-III	P9MSCX5L▲						
		I-II-III	P9MSCX5R▲						

(1) Electrical diagrams, see E.22

The catalogue numbers in bold are available from stock.

Keys for round metal shape

Standard version number	▲	95								
Standard version with specific number	▲	01	02	03	04	05	10	16	19	55 (Ronis)
FIAT version number	▲	33	34	37	38	40				
Colour		yellow	black	red	blue	orange				

(1) Key for square shape and round plastic shape, only standard version 95





For reference numbers, see chapter X, pg. X.8



Panel mounting



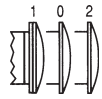

- A
- B
- C
- D
- E
- F
- G
- H
- I
- X

Illuminated push-buttons





		Cat. no.	Ref. no.	Cat. no.	Ref. no.	Cat. no.	Ref. no.
		see bottom		see bottom		see bottom	
		Metal	Plastic	Plastic			
							
Standard / Momentary							
	With diffused lens:						
	Flush	P9MPL●GD		P9XPL●GD		P9SPL●GD	
	Raised	P9MPL●SD		P9XPL●SD		P9SPL●SD	
	Recessed	P9MPL●ED					
Mushroom head / Momentary							
	Mushroom head Ø40 mm	P9MEM4●L		P9XEM4●L*			
	Mushroom head 30 mm					P9SEM3RL	186551
Mushroom head / With latch							
	Push-pull to release						
	Mushroom head Ø40 mm	P9MET4●L1		P9XET4●L1*		P9SET4RL1	186561
				* Color R, V or G			
Mushroom head / 3 positions							
	With mushroom Ø40 mm						
	1-0 fixed, 2 transient	P9MET4●L2		P9XET4RL2	185571		
	0 transient, 1-2 fixed	P9MET4●L3					



Illuminated selector switches with knob

		Function (1)			
2 positions					
Fixed		D	P9MSLD0●	P9XSLD0●	P9SSLD0●
3 positions					
Fixed		Z, B	P9MSLZ0●	P9XSLZ0●	P9SSLZ0●
With spring return		Z, B	P9MSLZ1●		
		Z, B	P9MSLZ5●		
		Z, B	P9MSLZ3●		

Illuminated selector switches with lever

		Function (1)			
2 positions					
Fixed		D	P9MSAD0●		
3 positions					
Fixed		Z, B	P9MSAZ0●		
With spring return		Z, B	P9MSAZ1●		
		Z, B	P9MSAZ5●		
		Z, B	P9MSAZ3●		

(1) Electrical diagrams, see E.22







The catalogue numbers **in bold** are available from stock.

Colours		red	green	yellow	orange	blue	white	clear
Lens	●	R	V	G	A	L	B	I
Mushroomheads	●	R	V	G	A	L	B	I
Knob/lever	●	R	V	G	A	L	B	I





For reference numbers, see chapter X, pg. X.8











Selector push-buttons (black coloured)

	Function (1)	Cat. no.	Ref. no.	Cat. no.	Ref. no.	Cat. no.	Ref. no.
				Metal	Plastic	Plastic	
							
2 positions							
	Fixed		201	P9MPS21G	184690		
			231	P9MPS22G	184691		
			235	P9MPS23G	184692		
3 positions							
	Fixed		301	P9MPS34G	184693		
			323	P9MPS35G	184694		

Toggle switches (black coloured)

2 positions									
	Fixed position		D	P9MCD	184695	P9XCD	185695	P9SCD	186695
3 positions									
	Fixed position		B	P9MCB	184696				
			B	P9MCC	184697				
	Transient to zero from one position								

Joysticks (black coloured)

2 positions + central zero position ⁽¹⁾							
	Without interlock		fixed positions	P9MMN2F	184700	P9XMN2F	185700
			transient positions	P9MMN2T	184701	P9XMN2T	185701
			1 transient - 3 fixed positions	P9MMN2A	184702		
			1 fixed - 3 transient positions	P9MMN2B	184703		
	With interlock		fixed positions	P9MMB2F	184710	P9XMB2F	185710
			transient positions	P9MMB2T	184711	P9XMB2T	185711
			1 transient - 3 fixed positions	P9MMB2A	184712	P9XMB2A	185712
			1 fixed - 1 transient positions	P9MMB2B	184713	P9XMB2B	185713
4 positions + central zero position ⁽¹⁾							
	Without interlock		fixed positions	P9MMN4F	184720	P9XMN4F	185720
			transient positions	P9MMN4T	184721	P9XMN4T	185721
	With interlock		fixed positions	P9MMB4F	184740	P9XMB4F	185740
			transient positions	P9MMB4T	184741	P9XMB4T	185741

(1) Electrical diagrams, see E.22

The catalogue numbers in **bold** are available from stock.

Panel mounting

A

B

C

D

E

F

G

H

I

X



A

B

C

D

E

F





G

H

I

X

Emergency lever

	Cat. no.	Ref. no.	Cat. no.	Ref. no.	Cat. no.	Ref. no.			
							Metal	Plastic	Plastic
									
	Red lever	P9MWR	184770						

Reset push-button

	White symbol on blue background	P9MRG	184771	P9XRG	185771	
---	--	-------	--------	-------	--------	--

Potentiometer operator (potentiometer not included)

	Black knob	P9MZ	184772	P9XZ	185772	P9SZ	186772
---	-------------------	-------------	--------	-------------	--------	-------------	--------

Buzzer

	Black coloured Bitonal sound Full voltage AC/DC Frequency: 2kHz Sound intensity: 80dB at 1 m Consumption: 3 to 9 mA 24 V 110-240 V			P9XBD P9XBM	185773 185774	P9SBD P9SBM	186773 186774
---	--	--	--	----------------	------------------	----------------	------------------

Pilot lights

	Standard Diffused lens (for filament bulb) Refracted lens (for neon bulb) Glass lens	P9ML●D	<i>see bottom</i>	P9XL●D	<i>see bottom</i>	P9SL●D	<i>see bottom</i>
		P9ML●R	<i>see bottom</i>				
		P9ML●V	<i>see bottom</i>				
	Unibloc (complete pilot light) Full voltage AC/DC BA9S max 382 V - 2 W not included Diffused lens Refracted lens				P9XU●DDO	<i>see bottom</i>	
	With resistor 220 V BA9S 110 V - 2 W included Diffused lens Refracted lens			P9XU●DRN	<i>see bottom</i>		





The catalogue numbers **in bold** are available from stock.

Colours		red	green	yellow	orange	blue	white	clear
Lens	●	R	V	G	A	L	B	I

For reference numbers, see chapter X, pg. X.8

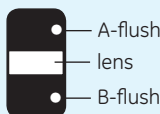
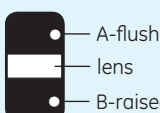

Double function push-buttons ⁽¹⁾

	Colours (2)	Plastic caps without symbols		Plastic caps with symbols	
		Cat. no.	Ref. no.	Cat. no.	Ref. no.
					
IP40 protection (acc. to IEC 529)					
 <p>With white lens assembled for indicator light. Black insert for not illuminated function included in the packaging.</p> <div style="display: flex; align-items: center;">  <ul style="list-style-type: none"> — A-flush — lens — B-flush </div> <div style="display: flex; align-items: center;">  <ul style="list-style-type: none"> — A-flush — lens — B-raised </div>	A - Black B - Red	P9DPLNRG00	186880	P9DPLNRG01	186890
	A - Green B - Red	P9DPLVRG00	186881	P9DPLVRG01	186891
	A - Black B - Red	P9DPLNRS00	186882	P9DPLNRS01	186892
	A - Green B - Red	P9DPLVRS00	186883	P9DPLVRS01	186893
Clear cap (silicon rubber)					
 <p>IP66 protection (acc. to IEC 529)</p>	A - flush B - flush	080CPDT	173208	080CPDT	173208
	A - flush B - raised	P9ADCST	187796	P9ADCST	187796

(1) With white lens assembled.
Black insert for not illuminated function included in the packaging.
(2) Integral caps, colours not replacable.

- A
- B
- C
- D
- E**
- F
- G
- H
- I
- X

A

B

C

D

E

F

G





H

I

X



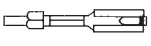













Contact blocks

		Cat. no.	Ref. no.
<p>Logic Reed</p> <p>A new range of LOGIC REED contact blocks with faston terminals for use with power lower than 12V - 5mA.</p> 	Contact type	NC	P9B01FH 187014
		NO	P9B10FH 187015
	Rated voltage	AC2 to 120V max. DC2 to 30V max.	
	Rated current	AC/DC - 0.001 to 0.15A max.	
	Rated power	AC - 8VA max. DC - 4.5W max.	
	Minimum centerline distance	30x32 mm.	
	Mounting on operators	through specific bayonet flange adaptor.	P9ACFSM 187846
	Full voltage power supply		P9PDHF 187056

		Contact type	Cat. no.	Ref. no.	
<p>With screw</p>  <p>min. 1 of 22 AWG (0.32 mm²) max. 2 of 12 AWG (3.3 mm²)</p> 					
<p>Faston</p>  <p>1 x (6.35 x 0.8 mm) 2 x (2.8 x 0.8 mm)</p> 					
<p>Terminal adapter</p> <p>printed circuit board adapter</p> 					

The catalogue numbers in **bold** are available from stock.

Power supplies

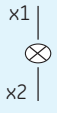
With screw  min. 1 of 22 AWG (0.32 mm ²) max. 2 of 12 AWG (3.3 mm ²)	Position on flange 2 3 1	Contact type	Cat. no.	Ref. no.		
						
		<input type="checkbox"/> <input checked="" type="checkbox"/> <input type="checkbox"/>	Full voltage ≅ IEC: BA9S max 380V-2W not included UL-CSA: BA9S max 250V-2W not included	P9PDNV0	187020	
			Logic Reed fullvoltage for low power	P9PDHF	187056	
		<input type="checkbox"/> <input checked="" type="checkbox"/> <input type="checkbox"/>	Long life 110/120V ≅ BA9S 130V-2W included	P9PRLVJ	187021	
		<input type="checkbox"/> <input checked="" type="checkbox"/> <input type="checkbox"/>	Resistor + Diode 220/240 V ~ BA9S 130V-2W included	P9PRDVN	187022	
		<input checked="" type="checkbox"/> <input type="checkbox"/>	Resistor 110/120V ≅ BA9S 60V-1.2W included	P9PRNVJ	187023	
			220/240V ≅ BA9S 130V-2W included	P9PRNVN	187024	
		<input checked="" type="checkbox"/> <input type="checkbox"/>	Resistor ENEL version BA9S 48V-2W included 110V ≅	P9PREVJ	187025	
			125/127V ≅	P9PREVL	187026	
		<input checked="" type="checkbox"/> <input type="checkbox"/>	UL-CSA: BA9S max 250V-2W not included Test full voltage (1) ≅ IEC: BA9S max 380V-2W not included	P9PDTV0	187027	
		<input checked="" type="checkbox"/> <input type="checkbox"/>	Test resistor (1) 220/240 V ≅ BA9S 130V-2W included	P9PRTVN	187028	
		<input checked="" type="checkbox"/> <input type="checkbox"/>	Transformer 50/60 Hz BA9S 6V-1.5W included	P9PTNV♦	see bottom	
		<input checked="" type="checkbox"/>	Multifunction (2) full voltage 24V ≅ BA9S 24V-2W included	P9PDMVD	187040	
		Multifunction (2) full voltage 110V ≅ BA9S 130V-2W included	P9PDMVJ	187041		
	<input checked="" type="checkbox"/>	Multifunction (2) Transformer 50/60 Hz BA9S 6V-0.6W included	P9PTMV♦	see bottom		
 Faston 1 x (6.35 x 0.8 mm) 2 x (2.8 x 0.8 mm)		<input type="checkbox"/> <input checked="" type="checkbox"/> <input type="checkbox"/>	Full voltage IEC: BA9S max 380V-2W not included UL-CSA: BA9S max 250V-2W not included	P9PDNF0	187055	
	 Integrated LED		<input type="checkbox"/> <input checked="" type="checkbox"/> <input type="checkbox"/>	Standard light	24V AC/DC	P9PLNVD♦
				120V AC	P9PLNVJ♦	see bottom
				230V AC	P9PLNVN♦	see bottom
Flashing light				24V AC/DC	P9PLFVD♦	see bottom
				120V AC	P9PLFVJ♦	see bottom
				230V AC	P9PLFVN♦	see bottom

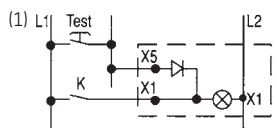

(2) Y1 Y2 Do not connect for flashing light
 Y1 Y2 Link to external contact in order to have steady or flashing light
 L C C closed = Steady light
 L C C open = Flashing light

LED colour	orange	white	yellow	blue	red	green
	A	B	G	L	R	V

The catalogue numbers in **bold** are available from stock.

Voltage	110-120	220-250	380	415-440	480-500
	♦	J	N	U	W Y
	:	J	N	U	- -

For reference numbers, see chapter X, pg. X.8



Panel mounting

- A
- B
- C
- D
- E
- F
- G
- H
- I
- X

A

B

C

D

E

F

G

H

I

X

Diagrams

Selector switches

Positions	Function	Contacts	Position on flange 2 3 1
	D	B10	
	D	B10 B01	
	D	B11	
	I	B11	
	H	B11 B11	
	B	B10 B10	
	E	B11	
	L	B11	
	U	B11 B11	
	Z	B11 B11	
	Z	B10 B01	
	X	B11 B11	
	Y	B11 B11	
	W	B11 B11	

Selector push-buttons

Positions	Function	Contacts	Normal Depressed	Position on flange 2 3 1
	201	B11 B11		
	231	B11 B11		
	235	B11 B11		
	301	B11 B11		
	323	B11 B11		

* Can not be depressed

Joysticks

Positions	Contacts	Position on flange 2 3 1
	B11	
	B11	
	B11	
	B11	

Toggle switches



Positions	Function	Contacts	Position on flange 2 3 1
	D	B11	
	B	B11	

Mushroom head push-buttons 3 pos.



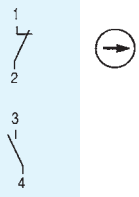

Function	Contacts	Position on flange 2 3 1
2	B01R B01	
3	B11	



Contact blocks

With screw	Contact type	Cat. no.	Ref. no.
		 min. 1 of 22 AWG (0.32 mm ²) max. 2 of 12 AWG (3.3 mm ²)	
		P9B10BN	187018

Power supplies

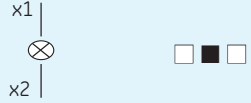
With screw	Position on flange 2 3 1	Bulb power supply	Cat. no.	Ref. no.
 min. 1 of 22 AWG (0.32 mm ²) max. 2 of 12 AWG (3.3 mm ²)		Full voltage ≅ IEC: BA9S max 380V-2W not included UL-CSA: BA9S max 250V-2W not included	 P9PDNB0	187070
		Standard light		
		24V AC/DC	P9PLNBD•	see bottom
		120V AC	P9PLNBJ•	see bottom
230V AC	P9PLNBN•	see bottom		

The catalogue numbers **in bold** are available from stock.

LED colour•	orange	white	yellow	blue	red	green
	A	B	G	L	R	V

For reference numbers, see chapter X, pg. X.8



Base mounting

- A
- B
- C
- D
- E
- F
- G
- H
- I
- X

Push-button stations in thermoplastic (Light grey coloured RAL 7035)

For panel and base mounting

- IP66 according to IEC529, EN 60529
- Engineered thermoplastic covers, bases and screws
- Self extinguishing Class V0, according to UL 94
- Rust resistant (4X according to UL 508)
- Total insulation with all thermoplastic operators
- Contact blocks and power supplies for both base and front mounting

Empty versions	Number of holes	Cat. no.	Ref. no.
Cover with holes Knockouts conduit entry	1 (yellow cover)	P9EPEG1	189000
	1	P9EPE01	189001
	2	P9EPE02	189002
	3	P9EPE03	189003
	4	P9EPE04	189004
	6	P9EPE06	189005

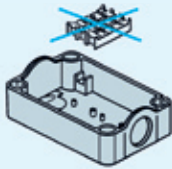
For panel mounting



Accessories	Description	Symbols	Cat. no.	Ref. no.
Write-on plates Bilaminated, self adhesive, 20 x 20 mm Black background engravable for white texts	Without text		P9AELN	189030
	Text in English (1) START		P9AELN202	189031
	STOP		P9AELN201	189032
	FORWARD		P9AELN214	189033
	REVERSE		P9AELN215	189034
	CLOSE		P9AELN205	189035
	OPEN		P9AELN206	189036
	UP		P9AELN204	189037
	DOWN		P9AELN203	189038
	LEFT		P9AELN222	189152
	RIGHT		P9AELN224	189154
		→	P9AELN006	189041
		I	P9AELN028	189042
		0	P9AELN029	189043

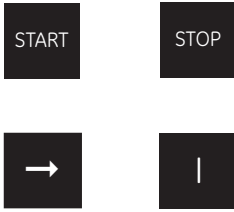

Earth terminal clamp

P9AEMT 189029

Equipped versions	Operators	Colour	Diagram	Name-plate	Cat. no.	Ref. no.
One unit	Flush push-button	green	1/3 4	I	P9EPA01Y02	189010
	Flush push-button	white	1/3 4	I	P9EPA01Y03	189011
	Emergency push-button with latch according to EN418 (yellow cover)	red	1/1 2/1	0	P9EPAG1Y0N	189007
	Emergency push-button with latch & status indicator according to EN418 (yellow cover)	red	1/1 2/1	0	P9EPAG1Y01W	189008
	Emergency push-button with latch according to EN418 - key to release (yellow cover)	red	1/1 2/1	0	P9EPAG1Y06N	189009







(1) Other languages on request

The catalogue numbers **in bold** are available from stock.



Push-button stations in thermoplastic (continued)

Equipped versions		Operators	Colour	Diagram	Name-plate	Cat. no.	Ref. no.	
	Two units	Flush push-buttons	green	$\begin{matrix} 13 \\ \diagdown \\ 4 \end{matrix}$	I	P9EPA02Y01	189016	
			red	$\begin{matrix} 1L \\ \diagdown \\ 2 \end{matrix}$	0			
 	Three units	Full voltage pilot light max 380V-2W not included	BA9S	white	$\begin{matrix} \text{⊗} \times 1 \\ \text{⊗} \times 2 \end{matrix}$	blank	P9EPA03Y01	189018
		Flush push-buttons	green	$\begin{matrix} 13 \\ \diagdown \\ 4 \end{matrix}$	I			
		Flush push-buttons	red	$\begin{matrix} 1L \\ \diagdown \\ 2 \end{matrix}$	0			
		Flush push-buttons	black	$\begin{matrix} 13 \\ \diagdown \\ 4 \end{matrix}$	↑	P9EPA03Y05		
Flush push-buttons	red	$\begin{matrix} 1L \\ \diagdown \\ 2 \end{matrix}$	0					
Flush push-buttons	black	$\begin{matrix} 13 \\ \diagdown \\ 4 \end{matrix}$	↓					

The catalogue numbers in **bold** are available from stock.

A

B

C

D

E

F

G

H

I

X

Equipped boxes

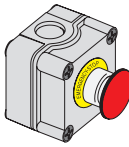
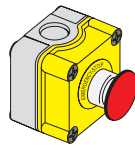
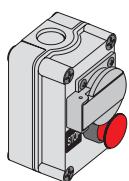
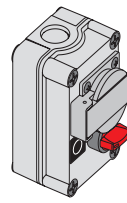
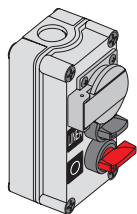
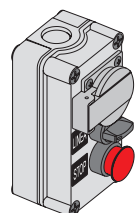
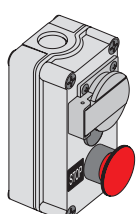
		Specially enclosures to use for shaft lifts (other versions, please contact us)				
		Composition	Individual operators	Cat. no.	Ref. no.	Pack
	One operator	Thermoplastic box. 1 element	P9EPE01	P9EPC01X00	215432	1
		Emergency push button mushroom head Ø40, push-pull to release	P9XET4RN1			
	1NC contact block	P9B01VN				
	1NO contact block	P9B10VN				
	Nameplate with inscription "EMERGENCY-STOP"	080XTGR02				
	PG16 packing gland					
		Thermoplastic box. Yellow cover. 1 element	P9EPEG1	P9EPC01X01	215433	1
		Emergency push-button mushroom head Ø40, push-twist to release	P9XER4RN			
	1NC contact block	P9B01VN				
	Nameplate with inscription "EMERGENCY-STOP"	080XTGR02				
	Two operators	Thermoplastic box. 2 elements	P9EPE02	P9EPL02X01	189136	1
		Emergency push-button mushroom head Ø28, push-twist to release	P9XER3RN			
	1NC contact block	P9B01VN				
	Nameplate with inscription "STOP"	P9AELN201				
	16A Schuko socket-outlet with cover					
		Thermoplastic box. 2 elements	P9EPE02	P9EPL02X02	189137	1
		Selector switch, 2 positions, with red knob	P9XSMD0R			
	1NC contact block	P9B01VN				
	Nameplate with inscription "O-I"	P9AELN039				
	16A Schuko socket-outlet with cover					
	Three operators	Thermoplastic box. 3 elements	P9EPE03	P9EPL03X01	189138	1
		Selector switch, 2 positions, with black knob	P9XSMD0N			
	1NC contact block	P9B01VN				
	1NO contact block	P9B10VN				
	Nameplate with inscription "LINEA"	P9AELN523				
	Selector switch, 2 positions, with red lever	P9XSVD0R				
	1NO contact block	P9B10VN				
	Nameplate with inscription "O-I"	P9AELN039				
	16A Schuko socket-outlet with cover					
		Thermoplastic box. 3 elements	P9EPE03	P9EPL03X02	189139	1
		Selector switch, 2 positions, with black knob	P9XSMD0N			
	1NC contact block	P9B01VN				
	1NO contact block	P8B10VN				
	Nameplate with inscription "LINEA"	P9AELN523				
	Emergency push-button mushroom head Ø28, push-twist to release	P9XER3RN				
	1NC contact block	P9B01VN				
	Nameplate with inscription "STOP"	P9AELN201				
	16A Schuko socket-outlet with cover					
		Thermoplastic box. 3 elements	P9EPE03	P9EPL03X03	189140	1
		Emergency push-button mushroom head Ø40, push-twist to release	P9XER4RN			
	1NC contact block	P9B01VN				
	Nameplate with inscription "STOP"	P9AELN201				
	Round plug	P9ARHPR				
	16A Schuko socket-outlet with cover					



Equipped boxes (continued)

Specially enclosures to use for shaft lifts
(other versions, please contact us)

Four operators

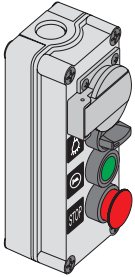

Composition	Individual operators	Cat. no.	Ref. no.	Pack
Thermoplastic box, 4 elements	P9EPE04	P9EPL04X01	189141	1
Selector switch, 2 positions, with black knob	P9XSM00N			
1NC contact block	P9B01VN			
1NO contact block	P9B10VN			
Nameplate with "Light" symbol	P9AELN100			
Standard/momentary push button with flush cap, green	P9XPNVG			
1NO contact block	P9B10VN			
Nameplate with "Bell" symbol	P9AELN099			
Emergency push-button mushroom head Ø28, push-twist to release	P9XER3RN			
1NC contact block	P9B01VN			
Nameplate with inscription "STOP"	P9AELN201			
16A Schuko socket-outlet with cover				

Push-button stations

A

B

C

D

E

F



G

H

I

X

Push-button stations in aluminium (Grey coloured RAL 7012)

For panel mounting	Protection	Number of holes	Type	Cat. no.	Ref. no.		
 <p>Cover with holes with conduit entry</p>	IP66 (according to IEC 529, EN 60529)	1	1	080SP1	170801		
		1	1M (1)	080SP1M	170831		
		2	2	080SP2	170802		
		2	2M (1)	080SP2M	170832		
		3	3	080SP3	170803		
		4	4	080SP4	170804		
		4	4M (1)	080SP4M	170834		
		6	6	080SP6	170806		
		8	8	080SP8	170807		
		12	12	080SP12	170808		
		18	18	080SP18	170809		
		24	24	080SP24	170810		
		35	35	080SP35	170811		
		<p>Cover with holes without conduit entry</p>	IP66 (according to IEC 529, EN 60529)	1	1	080SP1SFE	170836
				1	1M (1)	080SP1MSFE	170839
2	2			080SP2SFE	170842		
2	2M (1)			080SP2MSFE	170845		
3	3			080SP3SFE	170848		
4	4			080SP4SFE	170850		
4	4M (1)			080SP4MSFE	170851		
6	6			080SP6SFE	170852		
8	8			080SP8SFE	170854		
12	12			080SP12SFE	170857		
18	18			080SP18SFE	170860		
24	24			080SP24SFE	170862		
35	35			080SP35SFE	170864		
 <p>Cover without holes with conduit entry</p>	IP66 (according to IEC 529, EN 60529)			1	1	080SP1SFC	170835
				1	1M (1)	080SP1MSFC	170838
		2	2	080SP2SFC	170841		
		2	2M (1)	080SP2MSFC	170844		
		3	3	080SP3SFC	170847		
		4	4	080SP4SFC	170841		
		4	4M (1)	080SP4MSFC	170844		
		6	6	080SP6SFC	170847		
		8	8	080SP8SFC	170853		
		12	12	080SP12SFC	170856		
		18	18	080SP18SFC	170859		
		24	24	080SP24SFC	170859		
		35	35	080SP35SFC	170863		
		<p>Cover without holes without conduit entry</p>	IP66 (according to IEC 529, EN 60529)	1	1	080SP1SF	170837
				1	1M (1)	080SP1MSF	170840
2	2			080SP2SF	170843		
2	2M (1)			080SP2MSF	170846		
3	3			080SP3SF	170849		
4	4			080SP4SF	170843		
4	4M (1)			080SP4MSF	170846		
6	6			080SP6SF	170849		
8	8			080SP8SF	170855		
12	12			080SP12SF	170858		
18	18			080SP18SF	170861		
24	24			080SP24SF	170861		
35	35			080SP35SF	170865		

(1) With deep socle

Accessories

Description	Cat. no.	Ref. no.
Kit of two hinges for types 18, 24, 35 with holes	080KCSP	170883

Overall dimensions, see E.41

The catalogue numbers **in bold** are available from stock.



Notes















Grid area for notes.

Push-button stations

- A
- B
- C
- D
- E
- F
- G
- H
- I
- X



Caps for standard push-buttons



Colour	Cat. no.	Ref. no.	Cat. no.	Ref. no.	Cat. no.	Ref. no.	Cat. no.	Ref. no.	
	Flush and recessed		Raised		Flush		Raised		
Neutral									
	P9ARBG ●	18710 ■	P9ARBS ●	18720 ■	P9ASBG ●	18750 ■	P9ASBS ●	18760 ■	
With symbols ⁽¹⁾									
Stop 	Black	P9ARBGN 029	187150	P9ARBSN 029	187250	P9ASBGN 029	187550	P9ASBSN 029	187650
	Red	P9ARBGR 029	187110	P9ARBSR 029	187210	P9ASBGR 029	187510	P9ASBSR 029	187610
Start 	Black	P9ARBGN 028	187111	P9ARBSN 028	187211	P9ASBGN 028	187511	P9ASBSN 028	187611
	Green	P9ARBGV 028	187112	P9ARBSV 028	187212	P9ASBGV 028	187512	P9ASBSV 028	187612
	White	P9ARBGB 028	187151	P9ARBSB 028	187251	P9ASBGB 028	187551	P9ASBSB 028	187651
Continuous rectilinear motion 	Black	P9ARBGN 006	187117	P9ARBSN 006	187217	P9ASBGN 006	187517	P9ASBSN 006	187617
	Green	P9ARBGV 006	187118	P9ARBSV 006	187218	P9ASBGV 006	187518	P9ASBSV 006	187618
	White	P9ARBGB 006	187152	P9ARBSB 006	187252	P9ASBGB 006	187552	P9ASBSB 006	187652
Increase 	Black	P9ARBGN 017	187125						
Decrease 	Black	P9ARBGN 018	187127						
Reset 	Blue	P9ARBGL 037	187143			P9ASBGL 037	187543	P9ASBSL 037	187643
Stop/Reset 	Red	P9ARBGR 036	187144						
Test 	Black	P9ARBGN 030	187145	P9ARBSN 030	187245	P9ASBGN 030	187545	P9ASBSN 030	187645
	Green	P9ARBGV 030	187146	P9ARBSV 030	187246	P9ASBGV 030	187546	P9ASBSV 030	187646
Stop 	Red	P9ARBGR 201	187147	P9ARBSR 201	187247	P9ASBGR 201	187547	P9ASBSR 201	187647
Start 	Black	P9ARBGN 202	187148	P9ARBSN 202	187248	P9ASBGN 202	187548	P9ASBSN 202	187648
	Green	P9ARBGV 202	187149	P9ARBSV 202	187249	P9ASBGV 202	187549	P9ASBSV 202	187649
	White	P9ARBGB 202	188909	P9ARBSB 202	188978	P9ASBGB 202	188959	P9ASBSB 202	189928

(1) Other symbols on request

The catalogue numbers **in bold** are available from stock.

Colours		black	red	green	yellow	brown	blue	white	grey
Caps	●	N	R	V	G	M	L	B	H

Diffusers/insert for illuminated units

		Cat. no.	Ref. no.	Cat. no.	Ref. no.	Cat. no.	Ref. no.
		For pilot lights		For illuminated push buttons		For pilot lights and illuminated push buttons	
							
	Neutral	P9ARDLS	187300	P9ARDPL	187350	080QDF	173220
	With symbols ⁽¹⁾ on white background						
	Stop	P9ARDLS029	187301	P9ARDPL029	187351	080QDF029	187701
	Start	P9ARDLS028	187302	P9ARDPL028	187352	080QDF028	187702
Continuous rectilinear motion		P9ARDLS006	187305	P9ARDPL006	187355	080QDF006	187705
Increase		P9ARDLS017	187309	P9ARDPL017	187359	080QDF017	187709
Decrease		P9ARDLS018	187310	P9ARDPL018	187360	080QDF018	187710
Auto cycle		P9ARDLS026	187311	P9ARDPL026	187361	080QDF026	187711
Manual		P9ARDLS027	187312	P9ARDPL027	187362	080QDF027	185788
Locking		P9ARDLS031	187313	P9ARDPL031	187363	080QDF031	187713
Releasing		P9ARDLS032	187314	P9ARDPL032	187364	080QDF032	187714
Coolant		P9ARDLS001	187315	P9ARDPL001	187365	080QDF001	187715
Light		P9ARDLS002	187316	P9ARDPL002	187366	080QDF002	187716
Test		P9ARDLS030	187318	P9ARDPL030	187368	080QDF030	185789
Stop		P9ARDLS201	187319	P9ARDPL201	187369	080QDF201	187719
Start		P9ARDLS202	187320	P9ARDPL202	187370	080QDF202	187720

(1) Other symbols on request

The catalogue numbers in **bold** are available from stock.

A

B

C

D

E

F

G

H

I

X



A

B

C

D

E

F



G

H



I

X



Mushroom heads

Description	Cat. no.	Ref. no. see bottom	Cat. no.	Ref. no. see bottom		
					Plastic	
						
Momentary operators	Ø 28 mm	P9ARB3●				
	Ø 40 mm	P9ARB4●				
	Ø 60 mm	P9ARB6●				
	∩ 30 mm		P9ASB3●			
Push-pull operators	Ø 40 mm	P9ACB4●	P9ACB4●			



Knobs and levers

Description	Cat. no.	Ref. no. see bottom	Cat. no.	Ref. no. see bottom		
					Plastic	
						
Knob for selector switches	P9ACMN●		P9ACMN●			
Lever for selector switches	P9ARMV●					



Lenses

Description	Cat. no.	Ref. no. see bottom	Cat. no.	Ref. no. see bottom		
					Plastic	
						
Pilot lights	diffused version	P9ARGLD●	P9ASGLD●			
	refracted version	P9ARGLR●				
	glass version	P9ARGLV●				
Illuminated push-buttons	diffused version	P9ARGPD●	P9ASGPD●			
Illuminated mushroom head push-b.	momentary Ø 40 mm	P9ARGP4●				
	∩ 30 mm					
	push-pull Ø 40 mm	P9ACGP4●				
Illuminated selector switches	knob	P9ACGSL●	P9ACGSL●			
	lever	P9ARGSA●				

Rubber protective caps (IP66)

Description	Cat. no.	Ref. no. see bottom	Cat. no.	Ref. no. see bottom		
					Plastic	
						
Standard flush push-buttons	coloured (nitrilic rubber)	080CP●	P9ASCG●			
	clear (silicon rubber)	080CPT	P9ASCGT	170198 170790		
Raised push buttons	clear (silicon rubber)	P9ARCST	P9ASCST	187490 187791		

Spare boots for joysticks

 (a)	Standard rubber boot for joystick	(a)	P9ARSCMN	188043
 (b)	Standard rubber boot for joystick with interlock	(a)	P9ARSCMB	188044
	Silicone boot for joystick	(b)	P9ARSGMN	187495
	Silicone boot for joystick with interlock	(b)	P9ARSGMB	187496

The catalogue numbers in **bold** are available from stock.

Colours		black	red	green	yellow	orange	blue	white	clear
Mushroom heads	●	N	R	V	G	-	L	-	-
Knobs/lever	●	N	R	V	G	-	L	-	-
Lenses	●	-	R	V	G	A	L	B	I
Protective caps	●	N	R	V	G	-	-	-	-



Common accessories

Plugs	Description	Cat. no.	Ref. no.	Cat. no.	Ref. no.
		Plastic		Plastic	
	Round	P9ARHPR	187491		
	Square 30 x 30 mm			P9ASHP3	187792
	Rectangular 30 x 50 mm			P9ASHP5	187793
Protections					
	Collar for mushroom head push-buttons Ø40 mm.	P9ARRE4	187492		
	Protection cover padlockable for standard push-buttons, illuminated push-buttons, selector switches, illuminated selector switches with knob.	P9ACRCL	187840	P9ACRCL	187840
Flanges					
	With three positions Centre distances 30 x 50 mm	P9ACFS3	187841	P9ACFS3	187841
	With five positions Centre distances 50 x 50 mm	P9ACFS5	187842	P9ACFS5	187842
	With two positions For Logic Reed contact blocks	P9ACFSM	187846	P9ACFSM	187846
Adapter screw plug-in terminal					
	Only for Logic Reed contact blocks and power supplies	P9ACAFV	187847	P9ACAFV	187847
Adapter					
	Gives round control and signalling units a square appearance. Made in black thermoplastic. Can be used with nameplate for square operators P9ASTBS (see P.30). Excluded for mushroom flush buttons with positive break and types with 3 positions.	P9ARSN1	188805		
Push-on/push off					
	Device for standard push-buttons and illuminated push-buttons. To be added only to single pole contact blocks. The NO-contacts must be early closing types.	P9ACDPP	187843	P9ACDPP	187843
Extended screw					
	For reset push-buttons (setting min. 80, max. 170 mm)	P9ACVLR	187844	P9ACVLR	187844
Central contact driving plug					
	For standard momentary push-buttons and momentary mushroom head push-buttons.			P9ASHAC	187794
Tools					
	Locking ring wrench	P9ACWAF	187845	P9ACWAF	187845
	Bulb extractor	080ESL	170212	080ESL	170212
	Extractor for caps and lenses			P9ASEBG	187795

The catalogue numbers in bold are available from stock.

A

B

C

D

E

F



G

H

I



X

Spare keys

Description		Cat. no.	Ref. no.	
		Plastic		
				
Standard version	Code			
	3095	077C3095	173095	
	9901	077C9901	173901	
	9902	077C9902	173902	
	9903	077C9903	173903	
	9904	077C9904	173904	
	9905	077C9905	173905	
	9910	077C9910	173910	
	9916	077C9916	173916	
	9919	077C9919	173919	
	3353	077C3353	173353	
	(Ronis) 455	077CR455	173455	
FIAT version	Colour	Code		
	yellow	73033	077CF73033 173033	
	black	73034	077CF73034 173034	
	red	73037	077CF73037 173037	
	blue	73038	077CF73038 173038	
	orange	73040	077CF73040 173040	





Bulbs BA9s

Description			Cat. no.	Ref. no.	
			Plastic		
					
Filament type	Vn	Vn			
	6	0.6	BA9S606	187850	
	6	1.5	BA9S615	187851	
	12	2.0	BA9S122	187852	
	24	2.0	BA9S242	187853	
	30	2.1	BA9S30	187854	
	48	2.0	BA9S48	187855	
	60	1.2	BA9S6012	187856	
	130	2.0	BA9S130	187857	
Neon type					
	110	0.11	BA9SN110	187860	
	220	0.33	BA9SN220	187861	
Mono LED	VN AC/DC ± 10%				
		6	BA9S6L●	see bottom	
		12	BA9S12L●	see bottom	
		24	BA9S24L●	see bottom	
		48	BA9S48L●	see bottom	
		110	BA9S110L●	see bottom	
		(AC) 230	BA9S230L●	see bottom	



Colours	red	green	yellow	blue	white
●	R	V	G	L	B

Insert holders

Description		Cat. no.	Ref. no.	Cat. no.	Ref. no.
		Plastic		Plastic	
					
Supplied with neutral insert engravable on both sides or transparent.					
Standard 30 x 50 mm	Background black/red, white text	P9ARTBS	188000	P9ASTBS	188010
	Background white, black text	P9ARTWS	188005	P9ASTWS	188011
	Transparent	P9ARTTS	188012	P9ASTTS	188014
Extended 45 x 50 mm	Background black/red, white text	P9ARTBM	188001	P9ASTBM	188008
	Background white, black text	P9ARTWM	188008	P9ASTWM	188008
	Transparent	P9ARTTM	188019	P9ASTTM	188019

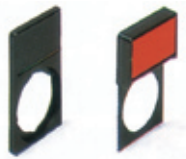

The catalogue numbers in **bold** are available from stock.

For reference numbers, see chapter X, pg. X.8



Rectangular inserts

For insert holders 30 x 50 mm		Neutral						
	Description	Cat. no.	Ref. no.	Description	Cat. no.	Ref. no.		
	black/red background	P9ACPBS	188015					
	white background	P9ACPWS	188017					
	transparent	P9ACPTS	188018					
		English (1)		French (1)				
START	black background	START	P9ACPBS202	188202	black background	MARCHE	P9ACPBS308	188308
		STOP	P9ACPBS201	188201		ARRET	P9ACPBS301	188301
		REVERSE	P9ACPBS215	188215		AVANT	P9ACPBS303	188303
		CLOSE	P9ACPBS205	188205		ARRIERE	P9ACPBS302	188302
		OPEN	P9ACPBS206	188206		FERMER	P9ACPBS309	188309
		UP	P9ACPBS204	188204		OUVRIR	P9ACPBS316	188316
		DOWN	P9ACPBS203	188203		MONTEE	P9ACPBS317	188317
		LEFT	P9ACPBS222	188222		DESCENTE	P9ACPBS304	188304
		RIGHT	P9ACPBS224	188224		GAUCHE	P9ACPBS306	188306
		FAST	P9ACPBS208	188208		DROITE	P9ACPBS305	188305
		SLOW	P9ACPBS207	188207		VITE	P9ACPBS324	188324
		OPEN-CLOSE	P9ACPBS234	188234		LENT	P9ACPBS307	188307
		HAND-AUTO	P9ACPBS243	188243		OUVERT-FERME	P9ACPBS335	188335
		STOP-START	P9ACPBS232	188232		MAIN-AUTO	P9ACPBS336	188336
	MARCHE	FORWARD-REVERSE	P9ACPBS231	188231		ARRET-MARCHE	P9ACPBS328	188328
		OFF-ON	P9ACPBS233	188233		AVANT-ARRIERE	P9ACPBS332	188332
		AUTO-OFF-HAND	P9ACPBS258	188258		HORS-EN	P9ACPBS331	188331
FORWARD-0-REVERSE		P9ACPBS239	188239		AUTO-0-MAIN	P9ACPBS334	188334	
0-1		P9ACPBS039	188030		AVANT-0-ARRIERE	P9ACPBS333	188333	
				0-1	P9ACPBS039	188030		
For insert holders 45 x 50 mm		Neutral						
	black/red background, white text	P9ARPBM	188002					
	white background, black text	P9ARPWM	188028					
	transparent	P9ARPTM	188019					

Round plates for emergency

		Diameter 59 mm			Diameter 78 mm		
	Description	Cat. no.	Ref. no.	Description	Cat. no.	Ref. no.	
Without text	yellow background	080XTGR	179514	black background	080XTG8	179515	
With text	yellow background			black background			
	EMERGENZA	080XTGR01	179525	EMERGENZA	080XTG801	179535	
	EMERGENCY STOP	080XTGR02	179526	EMERGENCY STOP	080XTG802	179536	
	ARRET D'URGENCE	080XTGR03	179510	ARRET D'URGENCE	080XTG803	179511	
	NOT - AUS	080XTGR04	179527	NOT - AUS	080XTG804	179537	
	NOODSTOP	080XTGR05	179528	NOODSTOP	080XTG805	179538	
	PARO EMERGENCIA	080XTGR06	179529	PARO EMERGENCIA	080XTG806	179539	
	NOTSTOP	080XTGR07	179530	EMERGENZA GENERALE	080XTG807	179540	
	PARAGEM EMERGENCIA	080XTGR08	179531	PARAGEM EMERGENCIA	080XTG808	179541	

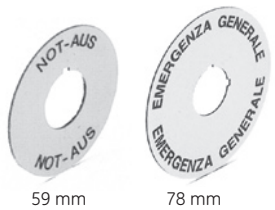

Neutral plate

		Description	Cat. no.	Ref. no.		
Snap-on system		For identification of contact blocks and power supplies	P9ACPIU	188016		

(1) Other languages on request. The catalogue numbers in **bold** are available from stock.

Dimensional drawings

Round operators - Push-buttons

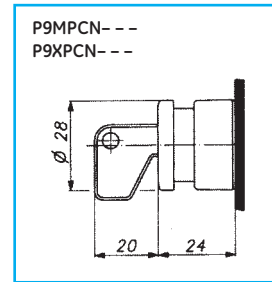
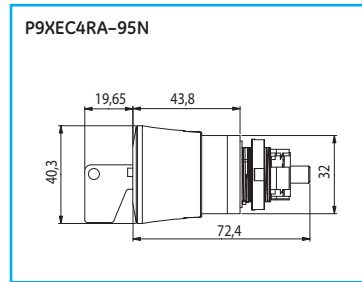
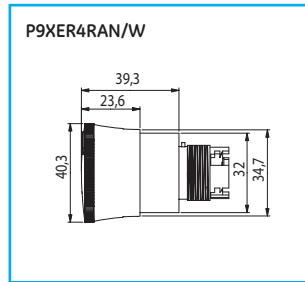
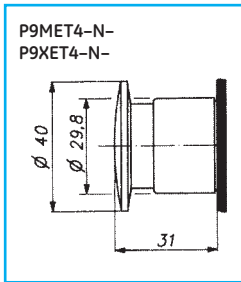
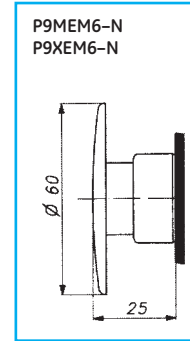
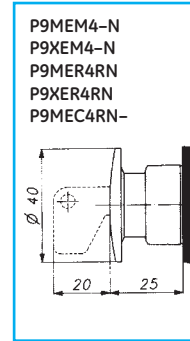
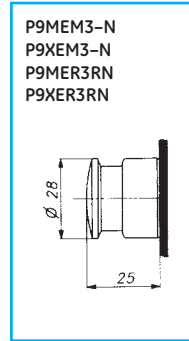
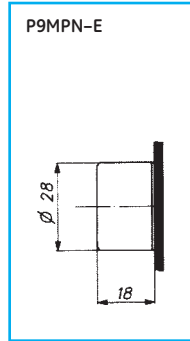
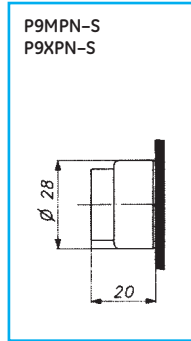
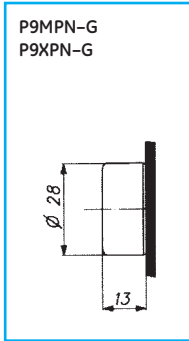

Round operators - Selector switches

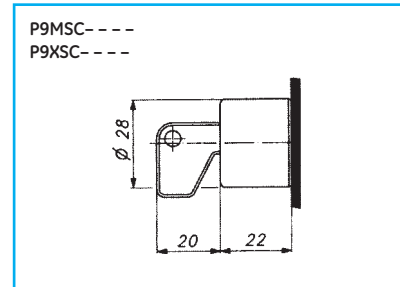
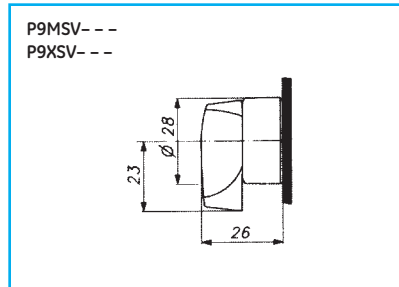
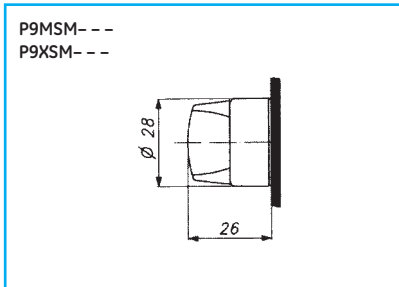

Round operators - Illuminated push-buttons and selector switches

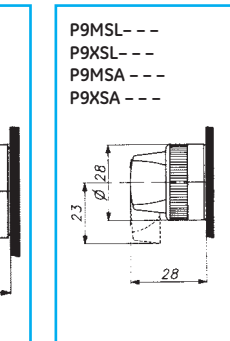
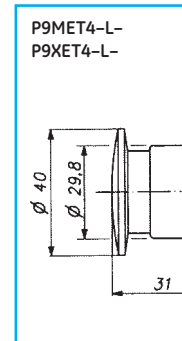
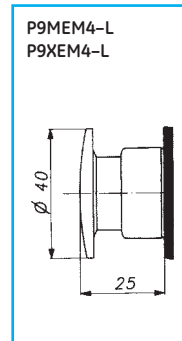
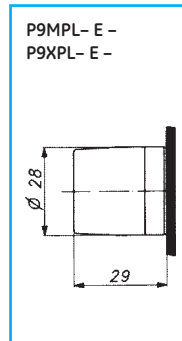
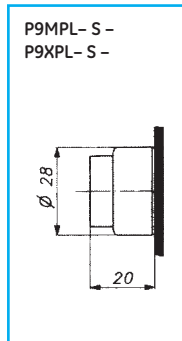
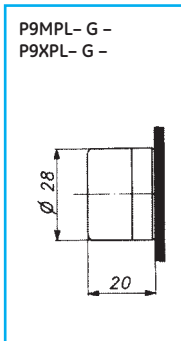

Round operators - Pilot lights

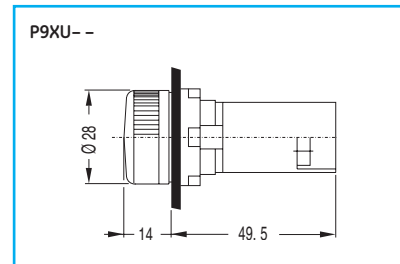
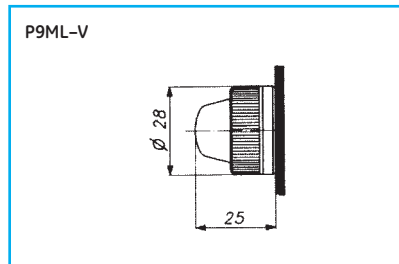
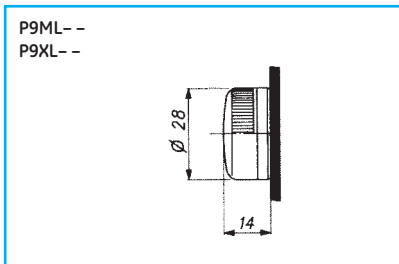

Round operators - Other devices

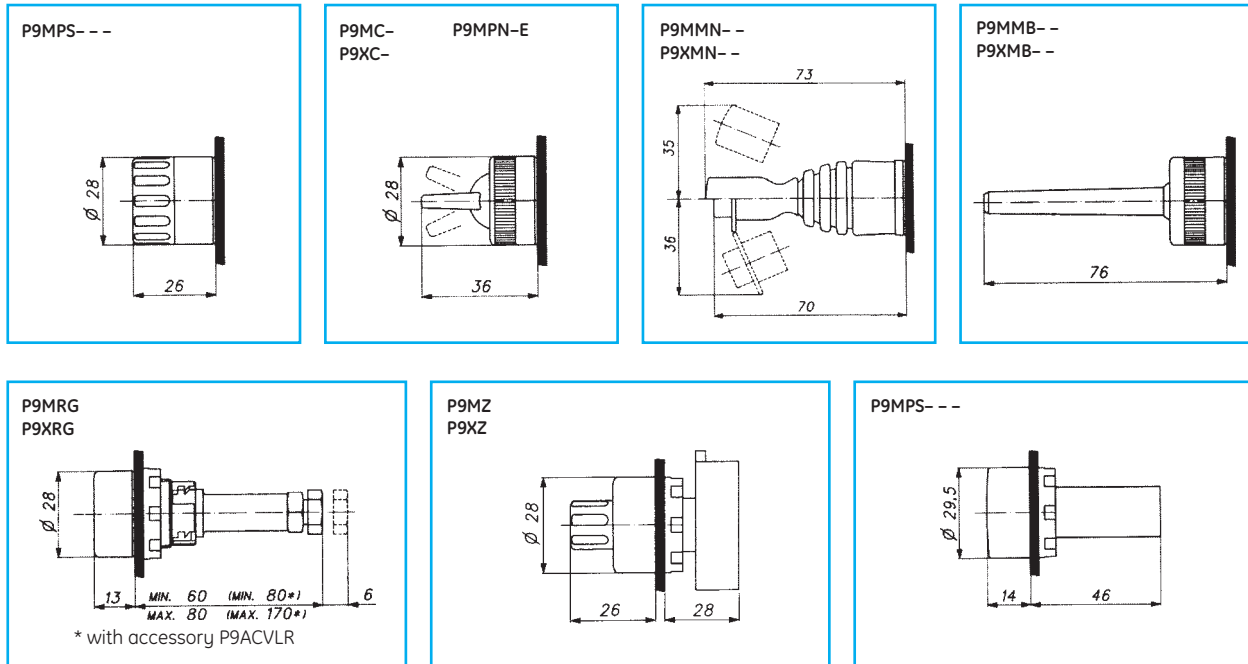

Square operators - Push-buttons

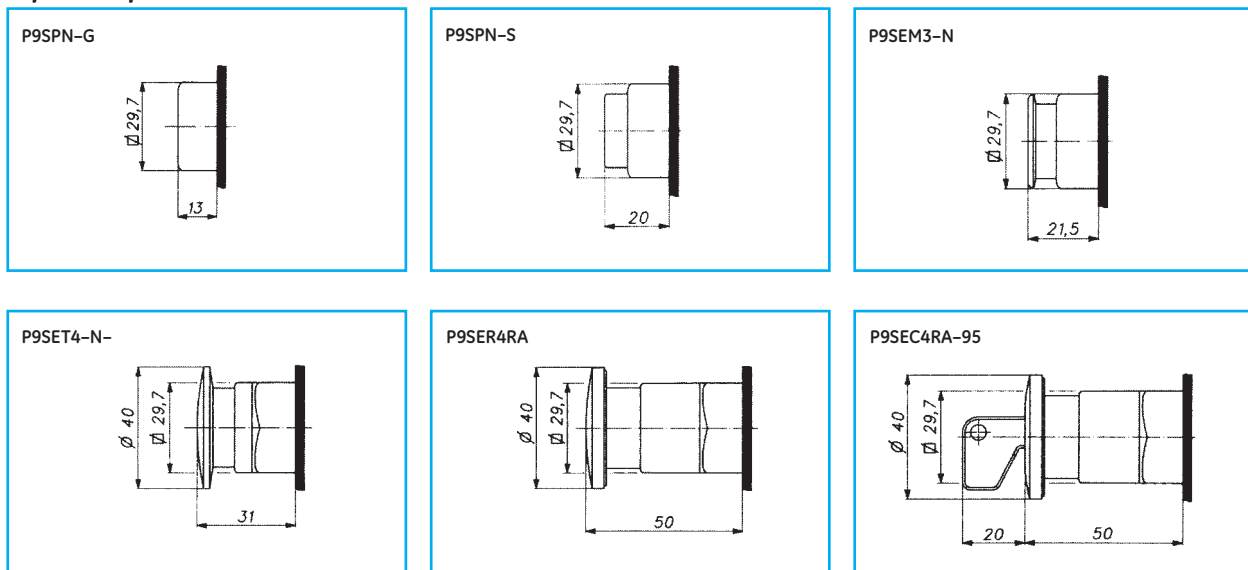

Square operators - Double function push-buttons

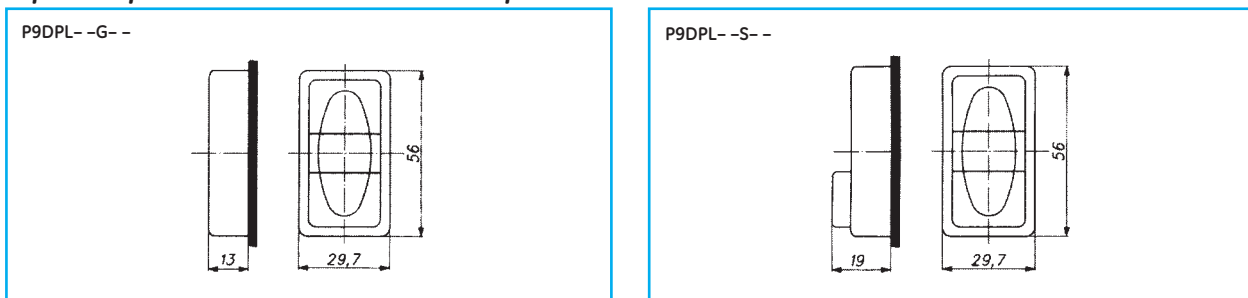

Dimensional drawings

Square operators - Selector switches

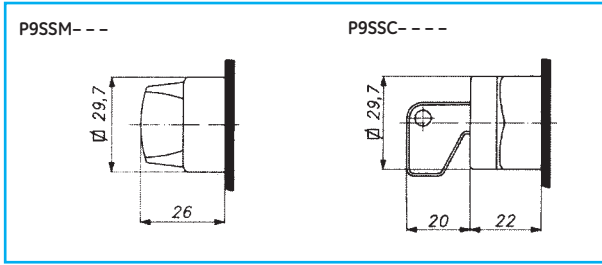

Square operators - Pilot lights

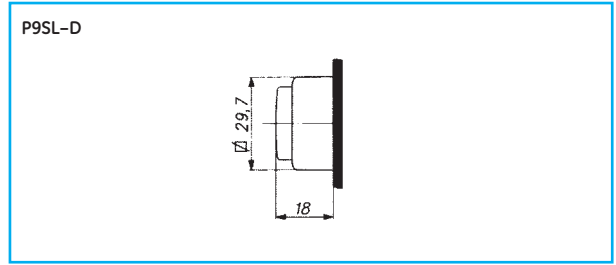

Square operators - Illuminated push-buttons and selector switches

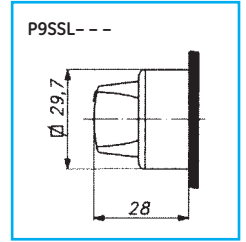
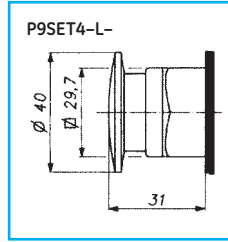
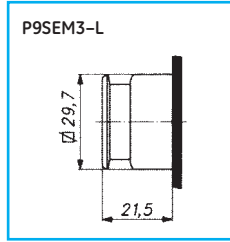
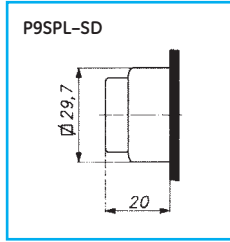
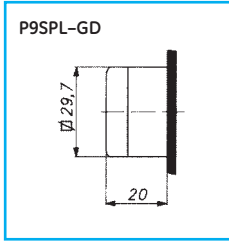

Square operators - Other devices

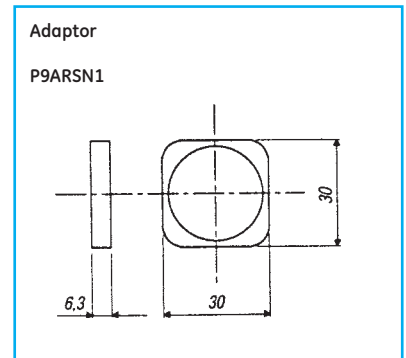
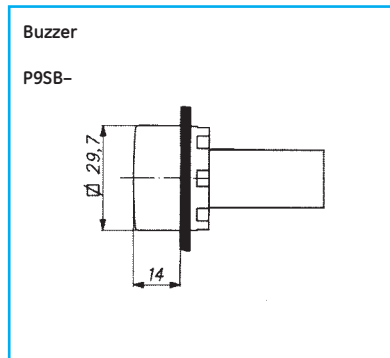
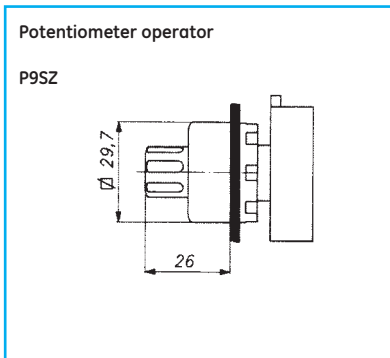
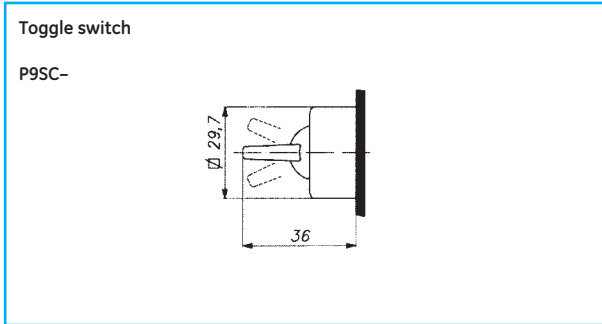

Contact blocks

P9B01V- / P9B10V-

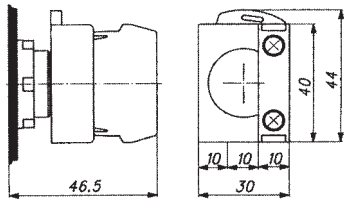

P9B01FN / P9B10FN

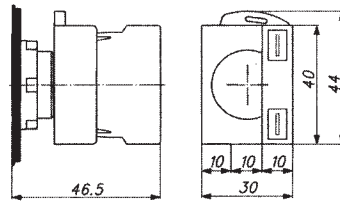

P9B011VN / P9B02VN / P9B20VN

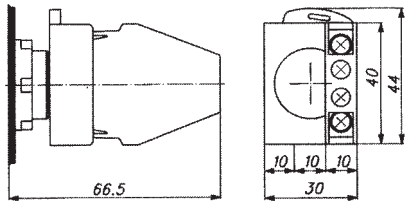

Power supplies

P9PDNV0 / P9PRLV- / P9PRDV-

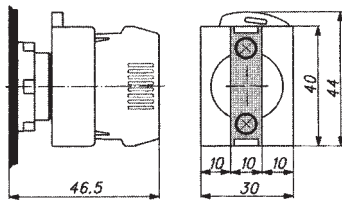

P9PDNF0

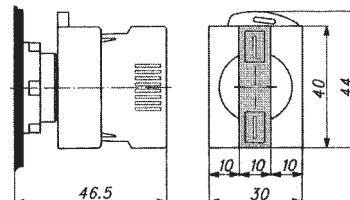

P9PRNV- / P9PDTV0 / P9PRTV-

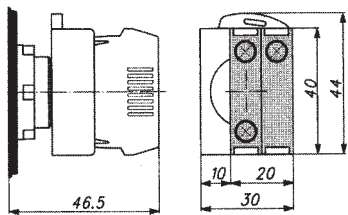

P9PREV-

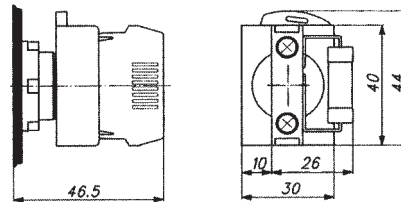

P9PTNV-

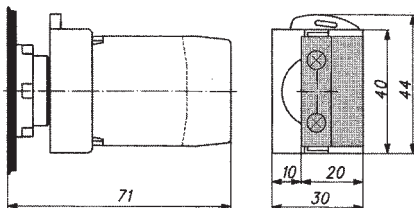

P9PDMV- / P9PTMV-

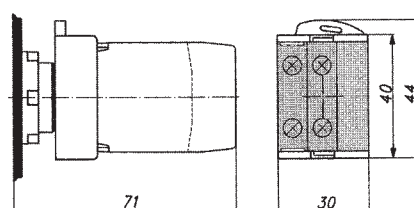

Dimensional drawings

Push-on / push-off devices

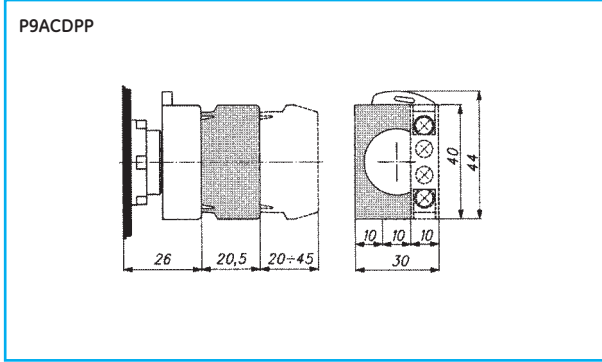

Protection cover

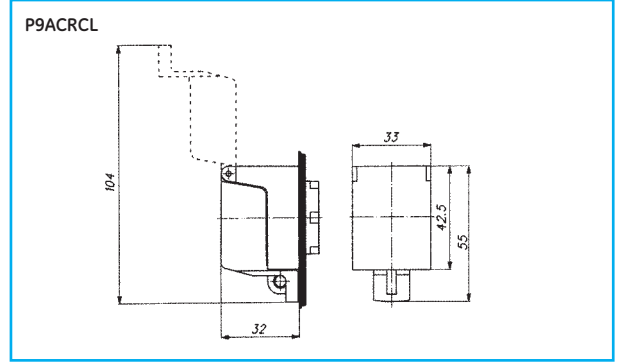

Insert holders and plates

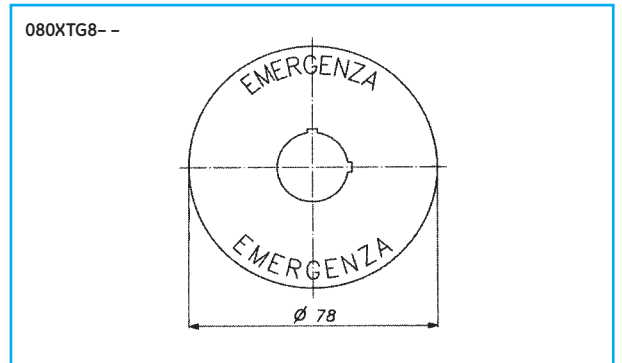
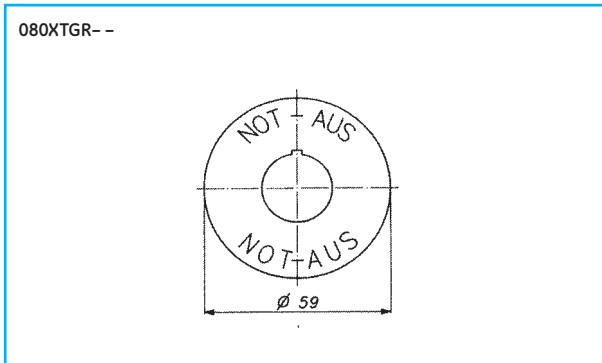
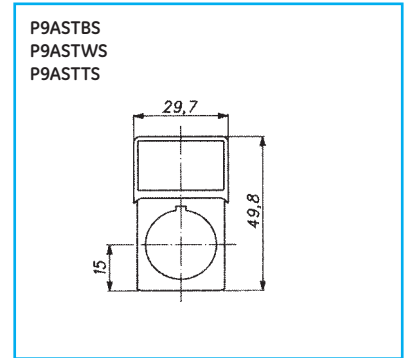
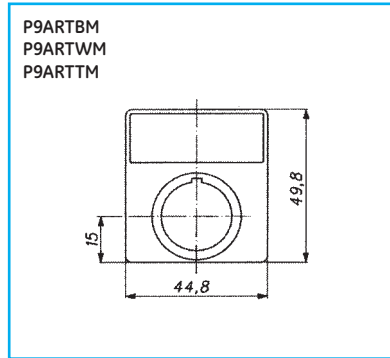
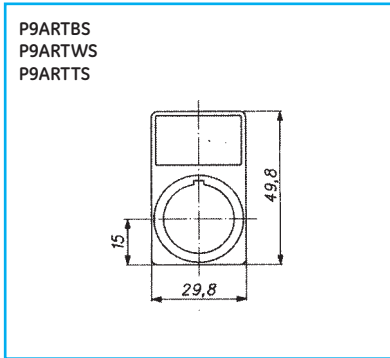

Contact blocks

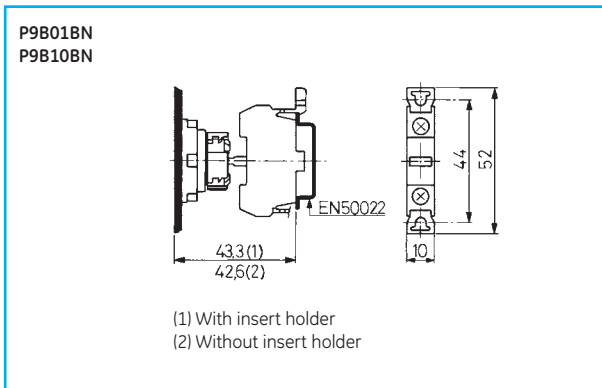

Power supplies

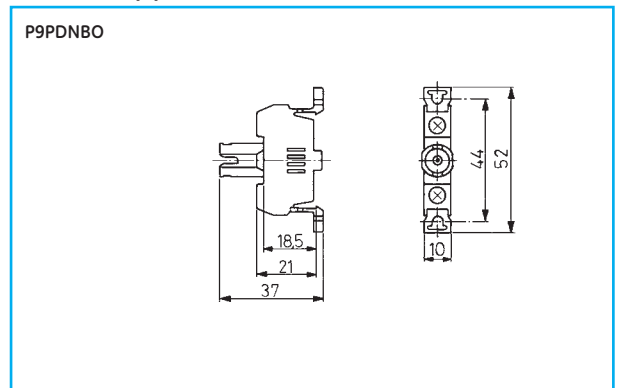

Overall dimensions

Enclosures for push-button stations in thermoplastic

Holes	A	B	C	E1	E2	H
1	72	46	16.5	23 ⁽¹⁾	15.5	57
2	110	78	16.5	23 ⁽¹⁾	21.5	95
3	140	108	16.5	23 ⁽¹⁾	21.5	125
4	175	143	16.5	23 ⁽¹⁾	21.5	160
6	235	200	19.5	29 ⁽²⁾	23	220

(1) Suitable for cable gland, with locknut, PG16 or 1/2" NPT
 (2) Suitable for cable gland, with locknut, PG21 or 3/4" NPT
 (3) Flush push-button: 13
 Pilot light: 14
 Emergency push-button: 50
 Key selector switch: 22
 For customized versions see operator dimensions.

Enclosures for push-button stations in aluminium

Type	Holes Ø 22		Dimensions						Fixing templates	
	vertic.	horizont.	A (mm)	B (mm)	C (mm)	D (mm)	E (mm)	F	HxLxØmax (mm)	position of the holes
1	1	-	87	87	75	72	21.5	PG 21	74x55x4	1-3
1M	1	-	87	87	100	97	21.5	PG 21	68x55x4	1-3
2	2	-	145	87	75	72	21.5	PG 21	132x55x4	1-3
2M	2	-	145	87	100	97	21.5	PG 21	126x55x4	1-3
3	3	-	195	87	100	97	21.5	PG 21	176x55x4	1-3
4	2	2	145	87	75	72	21.5	PG 21	132x55x4	1-3
4M	2	2	145	87	100	97	21.5	PG 21	126x55x4	1-3
6	3	2	195	87	100	97	21.5	PG 21	176x55x4	1-3
8	2	4	152	152	101.5	98.5	27	PG 29	136x119x6	1-3
12	3	4	205	230	101.5	98.5	27	PG 29	172x214x6	1-2-3-4
18	3	6	257	300	101.5	98.5	35	PG 36	221x282x6	1-2-3-4
24	4	6	257	300	101.5	98.5	35	PG 36	221x282x6	1-2-3-4
35	5	7	350	350	123	106.5	41	PG 36	180x180x10	1-2-3-4

A

B

C

D

E

F

G

H

I

X

Technical data

Compliance with standards

IEC 947.5.1 - VDE 0660 - NFC 63140
 CEI EN 60947.5.1 - UTE - BSI - NEMA
 CENELEC EN 50007

Approvals

UL (U.S.A.) - CSA (Canada) - RINA - CE

Climatic protections

The standard versions are suitable for use in the following climates:

Temperate climate	cat. 23/50 (DIN 50014)
Wet climate	cat. 23/83 (DIN 50015)
Hot wet climate	cat. 40/92 (DIN 50015)
Variable wet climate	FW24 (DIN 50016)

Temperature ranges

Operation	-25 °C to + 70 °C
Storage	-40 °C to + 70 °C

Protection degree of the operators

IP65 according to IEC 529 when they are mounted into enclosures with the same or a higher degree of protection.
 IP66 with appropriate protective caps.

Protection degree of the terminals

IP2x according to IEC 529.
 Fully integrated on signalling units, illuminated push-buttons and illuminated selector switches. With accessory on contact blocks for control units.

Rated insulation voltage

690V according to EN 60947.1

Impulse withstand voltage

4 kV according to EN 60947.1

Insulation class

Group C according to VDE 0110

Electric shocks protection

Class I according to IEC 536

Short-circuit protection

With fuses type gI of 10A according to IEC 947.5.1

Connection terminals

Connection terminals
 Screw type with retractable clamp.
 Clamping capacity of rigid and/or flexible conductors:
 - minimum 22 AWG (0.32 mm²)
 - maximum 12 AWG (3.3 mm²)

Performances of the contacts

- Slow acting
- Self-cleaning
- NC forced breaking
- Double break

Electrical performances

Rated thermal current I_{th} = 10 A

Performances according IEC 947.5.1

Categorie AC 15 (A600)									
Voltage	U _e (V)	24	48	60	110	220	380	500	600
Current	I _e (A)	10	10	10	6	3	2	1.5	1.2
Categorie DC 13 (P600)									
Voltage	U _e (V)	24	48	60	110	220	300	500	600
Current	I _e (A)	5	2.7	2	1.1	0.55	0.3	0.22	0.2
Categorie DC 13 (Q300) for illuminated push-buttons and illuminated selector switch									
Voltage	U _e (V)	24	48	60	110	220	300		
Current	I _e (A)	2.5	1.1	1	0.55	0.27	0.2		

Performances according to CSA and UL

AC Heavy Duty (A600)	
DC Standard Duty (Q300)	for illuminated push-buttons and illuminated selector switch

Electrical endurance

Alternative current 50/60 Hz cat. AC 15

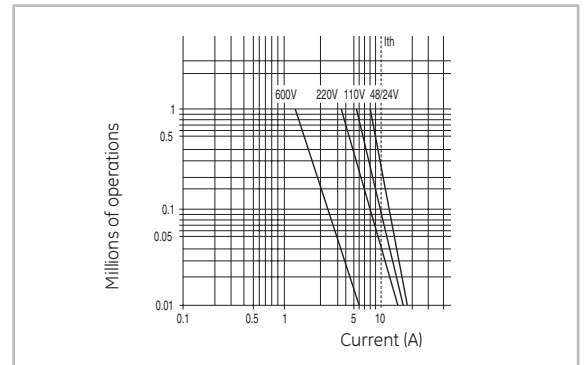

Direct current cat. DC 13

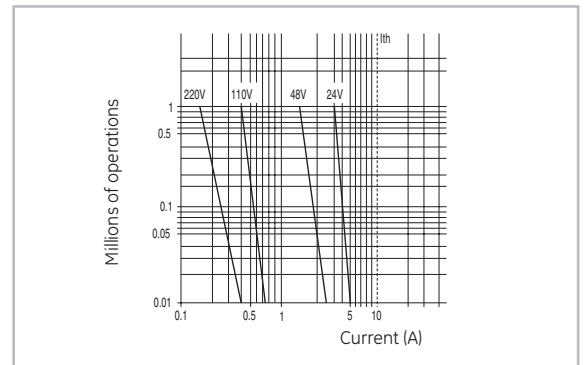

Mechanical endurance

Joysticks	0.5 x 10 ⁶ op.
Key push-buttons	
Locking emergency	1 x 10 ⁶ op.
Knob selector switches	
Lever selector switches	
Key selector switches	
Illuminated selector switches	
Selector push-buttons	
Timed push-buttons	3 x 10 ⁶ op.
Illuminated push-buttons	
Momentary std push-buttons	
Momentary mush. push-buttons	

Number of contact blocks

Momentary standard push-buttons	4 double pole
Momentary mush. push-buttons	(8 single pole)
Key push-buttons	4 double pole
Locking emergency	(4 single pole)
Selector switches	6 double pole
(4 pos. types excl)	(6 single pole)
4 pos. selector switches	2 double pole
Selector push-buttons	6 double pole
	(6 single pole)
Joysticks 2 and	4 double pole
4 positions	(4 single pole)
Illuminated push-buttons	For different contacts
Illuminated selector switches	configuration, contact our sales office

Fitting of units

The units of Series 077 are designed for fitting onto panels with a thickness between 1 and 7 mm., with holes of 30.5 mm. diameter, according to rules established by EN 60947.5.1.

A special metal ring supplied with each unit or one of the name plates included among the fittings, enables the unit to be exactly positioned.

All equipment is supplied with a set of spacing rings to adjust variations in the thickness of the panel thus ensuring a uniform front protrusion.

For a correct fitting, it needs to observe the diagram below and tables indications.

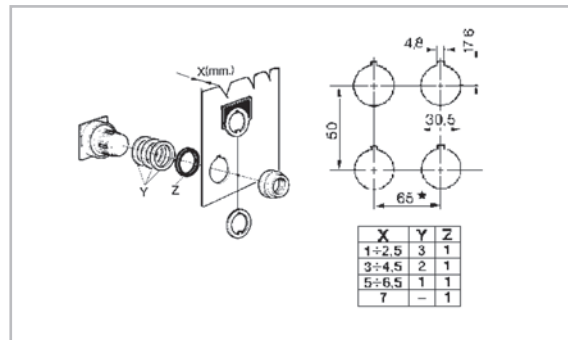

A

B

C

D

E

F

G

H

I

X

A

B

C

D

E

F





G

H

I

X

Push-buttons





Standard/Momentary	Description	Contacts	Cat. no.	Ref. no.
		NC+NO	077P11	180019
		NC	077P01	180039
		NO	077P10	180029
Standard/Time delayed ⁽¹⁾	Contacts delayed at the release of the push button. Accuracy ± 5% Setting range: 0,1 - 30 sec. 10 - 180 sec.	NC+NO	077P11T30	180120
		NC+NO	077P11T180	180121
To complete by	Fixing kits With 4 coloured caps: black, red, green, yellow	Ring type with guard	077GGBCN	180020
		without guard	077GSBCN	180010
	With 4 coloured caps: brown, orange, blue, white	Ring type with guard	077GGBCS	180050
		without guard	077GSBCS	180040
	With 1 clear and 4 marking etched on both sides	Ring type with guard	077GGBCF	180137
		without guard	077GSBCF	180136

(1) Not approved by RINA and Lloyd's Register

The catalogue numbers **in bold** are available from stock.



Push-buttons

Mushroom head/Momentary		Description	Contacts	Cat. no.	Ref. no.
			NC+NO	077E11	180049
			NC	077E01	180069
			NO	077E10	180059
Mushroom head/ Emergency with latch		Push-twist to release	NC+NO	077RE11	180079
			NC	077RE01	180099
			NO	077RE10	180089
	With keylock ⁽¹⁾		Key withdrawable in positions I & II		
	 <p>Locking (type G unlock)</p>	Lockable in position: normal & depressed	NC+NO	077PC11C	180100
		depressed without pre-setting ⁽²⁾	NC+NO	077PC11G	180104
To complete by		Description	Diameter	Cat. no.	Ref. no.
	Mushroom head caps				
	For momentary push-button	Ø 35 mm	077E●	see bottom	
		Ø 60 mm	077EE●	see bottom	
	For push-twist to release push-button	Red Ø 35 mm	077RER	180090	
		Red Ø 60 mm	077ECR	181602	
For keylock push-button	Red Ø 60 mm	077ECR	181602		

The catalogue numbers in **bold** are available from stock.

Colours	black	red	yellow
●	N	R	G

- (1) Supplied with two standard keys 3095.
- (2) Combined with mushroom head 077ECR makes an emergency with latch push-key to release.

For reference numbers, see chapter X, pg. X.10



A

B

C

D

E

F

G

H

I

X

A

B

C

D

E

F







G

H







I

X

Selector switches with knob

2 positions			Function (1)	Contacts	Cat. no.	Ref. no. <i>see bottom</i>
	Fixed		D	NC+NO	077SDN11	180170
			H	NC+NO	077SHN11	180180
3 positions						
	Fixed		B	NC+NO	077SBN11	180230
			U	2NC+2NO	077SUN22	180440
			Z	2NC+2NO	077SZN22	180480
	With spring return		B	NC+NO	077SBN11SC	180240
			B	NC+NO	077SBN11DC	180250
			B	NC+NO 2NC + 2NO	077SBN11RC 077SN22RC	180260 180510

Selector switches with lever









2 positions			Function (1)	Contacts	Cat. no.	Ref. no.
	Fixed		D	NC+NO	077SLD11	180601
3 positions						
	Fixed		B	NC+NO	077SLB11	180607
			Z	2NC+2NO	077SLZ22	180623
	With spring return		Z	2NC+2NO	077SLZ22DC	180625
			Z	2NC+2NO	077SLZ22RC	180626
	Fixed		X	2NC+2NO	077SLX22	180606

The catalogue numbers in **bold** are available from stock.

(1) Electrical diagrams, see E.55



Selector switches with key ⁽¹⁾

2 positions		Function (2)	Contacts	Key removal	Cat. no.	Ref. no.
	Fixed		D	NC+NO NC+NO NC+NO	I II I-II	077SCD1101 180630 077SCD1105 180631 077SCD1109 180632
	With spring return		I	NC+NO	0	077SCI11DC03 180640
			H	NC+NO	0	077SCH11SC03 180636
3 positions						
	Fixed		B	NC+NO	I-0-II	077SCB1120 180843
	With spring return		B	NC+NO	I-0	077SCB11DC07 180852
Z			2NC+2NO	I	077SCZ22DC01 180906	
		B	NC+NO	0	077SCB11RC03 180853	

The catalogue numbers in **bold** are available from stock.

(1) Supplied with two standard keys 3095.
 (2) Electrical diagrams, see E.55

A

B

C

D

E

F

G

H









I

X

For reference numbers, see chapter X, pg. X.10





Joysticks

2 positions + central zero position		Function ⁽¹⁾	Contacts	Cat. no.		Ref. no.		
				Without interlock	With interlock			
 	Fixed position	N	2NC+2NO	077MTS2422	180910	077MTS2422B	181000	
		R	2NC+2NO	077MTS2422R	180912	077MTS2422RB	181002	
	Transient position	N	2NC+2NO	077MT24S22	180911	077MT24S22B	181001	
		R	2NC+2NO	077MT24S22R	180913	077MT24S22RB	181003	
4 positions + central zero position								
 	Fixed positions	N	2NC+2NO	077MTS123422	180914	077MTS123422B	181004	
	Transient positions		2NC+2NO	077MT1234S22	180915	077MT1234S22B	181005	
2+2 positions + central zero position								
 	Fixed positions	X	4NC+4NO	077M2S2SX44	180918	077M2S2SX44B	181008	
	Transient positions		4NC+4NO	077M2T2TX44	180919	077M2T2TX44B	181009	
	4,8 transient -3,7 fixed		4NC+4NO	077M2S2TX44	180921			
	Transient positions	Y	4NC+4NO	077M2T2TY44	180923			
4+4 positions + central zero position								
 	Transient positions	X	8NC+8NO	077M4T4TX88	180927			
	2,4,6,8 transient -1,3,5,7 fixed		8NC+8NO	077M4S4TX88	180929	077M4S4TX88B	181019	
	Transient positions	Y	8NC+8NO	077M4T4TY88	180931	077M4T4TY88B	181021	

The catalogue numbers in **bold** are available from stock.

(1) Electrical diagrams, see E.55

Illuminated push-buttons

Momentary	Description	Contacts	Cat. no.	Ref. no.
	Full voltage ~ / $\overline{\overline{\overline{\quad}}}$ BA9s max 380V - 2 W not included	NC+NO NO+NO NO	077PLM11D0 077PLM20D0 077PLM10D0	181040 181041 181043
	With transformer 50/60Hz BA9s6V-1.5W included	NC+NO	077PLM11T♦	
To complete by:				
Lenses				
	Standard		077GPL●	see bottom
	Mushroom head Ø 35 mm (to use with the fixing ring 077GG03)		077GELR	180971
Locking rings				
	Without guard		077GG03	180980
	With metal guard		077GGM	180981
	With transparent guard		077GGT	180982

The catalogue numbers in **bold** are available from stock.

Suffix	110-120V	220-250V
♦	J	N

Colours	red	green	yellow	orange	blue	white	clear
Standard lenses	R	V	G	A	BL	B	I

Control and signalling units Ø 30 mm

A

B

C

D

E

F

G

H





I

X

For reference numbers, see chapter X, pg. X.10



Illuminated selector switches

2 positions		Function (1)	Contacts	Cat. no.	Ref. no.
	Fixed I II Full voltage ~ / $\overline{=}$ BA9s max. 380V-2W not included	D	NC+NO	077ISD11D0	181060
3 positions		Function (1)	Contacts	Cat. no.	Ref. no.
	Fixed I 0 III Full voltage ~ / $\overline{=}$ BA9s max. 380V-2W not included	B	NC+NO	077ISB11D0	181170
	With spring return I 0 II Full voltage ~ / $\overline{=}$ BA9s max. 380V-2W not included	B Z	NC+NO NC+NO	077ISB11D0RC 077ISZ11D0RC	181174 181176
To complete by:					
	Lenses				
	Knob			077MIS●	see bottom

(1) Electrical diagrams, see E.55

The catalogue numbers **in bold** are available from stock.







Suffix	110-120V	220-250V
◆	J	N

Colours	red	green	yellow
●	R	V	G

For reference numbers, see chapter X, pg. X.10



Pilot lights

	Description	Cat. no.	Ref. no.
	Full voltage ~ / \equiv BA9s max. 380V-2W not included	077LDNV0	181300
	With resistor ~ / \equiv 110-120V, BA9s60V-1.2W included 220-240V, BA9s130V-2W included	077LRNVJ 077LRNVN	181301 181302
	With transformer 50/60Hz BA9s6v-1.5w included	077LTNV♦	
	Multifunction (1) full voltage 24V ~ / \equiv BA9s24V-2W included	077LDMVD	181305
	Multifunction (1) with transformer 50/60 Hz BA9s6V-0.6W included	077LTMV♦	
To complete by:			
	Lenses		
	plastic version	077GL●	see bottom
	Full voltage ~ / \equiv For bulb E14 base max 660V(1)-6W not included	077DLE14	181260
To complete by:			
	Lenses		
	For pilot lights 077DLE14 plastic version	099GW1●	see bottom

The catalogue numbers **in bold** are available from stock.

Suffix	110-120V	220-250V
♦	J	N

Colours	red	green	yellow	orange	blue	white	clear
●	R	V	G	A	BL	B	I

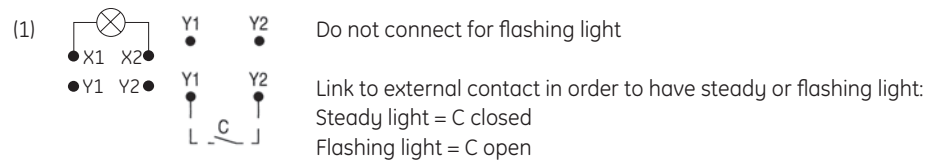

For reference numbers, see chapter X, pg. X.10



A

B

C

D

E

F









G

H

I

X

Accessories

	Description	Cat. no.	Ref. no.			
	Push-on/push-off device For momentary standard push-buttons Converts momentary push-button to push-on/push-off. This device can only be used with 077-01 (NC) and/or 077-10A (NO early make) contact blocks.	077DPP	181550			
	Push-pull to release device For momentary mushroom push-buttons Converts momentary mushroom push-button to push to latch/pull to release.	077DAE	181554			
	Handles Knob for selector switches	077M●	see bottom			
	Protection Guard-ring for mushroom head push-button dia 35 mm.	077GE35	181620			
	Plug For unused mounting hole.	077TPF	181601			
	Potentiometer operator Suitable for potentiometers with shaft 50 mm long and 6 mm diameter. Potentiometer not included.	077OPZ	181570			
	Rubber protective caps For standard push-buttons - coloured - clear	077CP●	see bottom			
		077CPT	181588			
	Rubber protective caps For illuminated standard push-buttons - clear For knob selector switches - black colour with clear knob	077CPLT	181600			
		077CST	181603			
	Spare keys Standard version	Code				
		3095	077C3095 173095			
	Bulbs BA9s	Filament type				
		Vn	Wn			
		6	0.6	BA9S606	187850	
		6	1.5	BA9S615	187851	
		12	2	BA9S122	187852	
		24	2	BA9S242	187853	
		30	2.1	BA9S30	187854	
		48	2	BA9S48	187855	
		60	1.2	BA9S6012	187856	
		130	2	BA9S130	187857	
		Neon type	110	0.11	BA9SN110	187860
			220	0.33	BA9SN220	187861
		Mono LED	Vn AC/DC ± 10%			
			6		BA9S6L●	see bottom
	12		BA9S12L●	see bottom		
	24		BA9S24L●	see bottom		
	48		BA9S48L●	see bottom		
	110		BA9S110L●	see bottom		
	(DC) 230		BA9S230L●	see bottom		





The catalogue numbers **in bold** are available from stock.

Colours ●	black	red	green	yellow	blue	white
Knobs	N	R	V	G	BL	-
Protective caps	N	R	V	G	-	-
Mono LED	-	R	V	G	BL	B









For reference numbers, see chapter X, pg. X.10

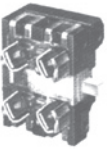
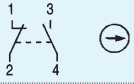

Nameplates

	Description	Cat. no.	Ref. no.
	For push-button and pilot lights		
	Without text (black background)	077TNA	181650
	With text in English (black background)	077TNA40	181840
	For 2 position selector switch and selector push-button		
	Without text (black background)	077TNA2	181660
	With text (black background)	077TNA230	181930
	For 3 position selector switch and selector push-button		
	Without text (black background)	077TNA3	181670
	With text (black background)	077TNA301	181951
		077TNA312	181962
	077TNA313	181963	
	Diameter 62 mm for emergency push-buttons		
	Without text (yellow background)	077TGR	181720
	With text (yellow background): EMERGENCY STOP	077TGRO2	181722

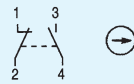
Contact blocks

2 positions		Contacts	Cat. no.	Ref. no.
	Standard			
	For all the applications Illuminated push-buttons and illuminated selector switches excluded			
		NC+NO	077-11	180001
		NC	077-01	180003
		NO	077-10	180002
		NC late opening	077-01R	180008
		NO early closing	077-10A	180007
	Accessories for contact blocks 077-... IP2X protection	for use with NO for use with NC for use with NO+NC	077PTB10 077PTB01 077PTB11	181608 181609 181615
	For 2 + 2 and 4 + 4 positions joysticks Snap action		099SPDTDB	180009
		For illuminated push-buttons and illuminated selector switches		
		NC+NO	P9B11VN	187000
		NC	P9B01VN	187001
		NO	P9B10VN	187002

The catalogue numbers in **bold** are available from stock.



A

B

C

D

E

F





G

H

I

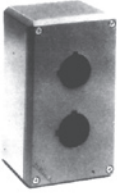
X

Enclosures for push-button stations in aluminium alloy (Grey RAL 7012)

			Cat. no.	Ref. no.	
	Cover with holes with conduit entry	No. of holes	Type		
		1	1	077SP1	180521
		1	1M	077SP1M	180522
		2	2	077SP2	180523
		2	2M	077SP2M	180524
		3	3	077SP3	180525
		4	4V	077SP4V	180526
		4	4	077SP4	180527
		6	6	077SP6	180528
		9	9	077SP9	180529
		12	12	077SP12	180530
		16	16	077SP16	180531
		20	20	077SP20	180532
		25	25	077SP25	180533
		30	30	077SP30	180534
		36	36	077SP36	180535
			Cover with holes without conduit entry	No. of holes	Type
1	1			077SP1SFE	180536
1	1M			077SP1MSFE	180537
2	2			077SP2SFE	180538
2	2M			077SP2MSFE	180539
3	3			077SP3SFE	180540
4	4V			077SP4VSFE	180541
4	4			077SP4SFE	180542
6	6			077SP6SFE	180543
9	9			077SP9SFE	180544
12	12			077SP12SFE	180545
16	16			077SP16SFE	180546
20	20			077SP20SFE	180547
25	25			077SP25SFE	180548
30	30			077SP30SFE	180549
36	36			077SP36SFE	180550
	Cover without holes with conduit entry			Type	
		1	080SP1SFC	170835	
		1M	080SP1MSFC	170838	
		2	080SP2SFC	170841	
		2M	080SP2MSFC	170844	
		3	080SP3SFC	170847	
		4V	077SP4VSFC	180551	
		4	080SP8SFC	170853	
		6	080SP12SFC	170856	
		9	080SP12SFC	170856	
		12	080SP18SFC	170859	
		16	080SP18SFC	170859	
		20	080SP35SFC	170863	
		25	080SP35SFC	170863	
		30	077SP36SFC	180552	
		36	077SP36SFC	180552	
			Cover without holes without conduit entry	Type	
1	080SP1SF			170837	
1M	080SP1MSF			170840	
2	080SP2SF			170843	
2M	080SP2MSF			170846	
3	080SP3SF			170849	
4V	077SP4VSF			180553	
4	080SP8SF			170855	
6	080SP12SF			170858	
9	080SP12SF			170858	
12	080SP18SF			170861	
16	080SP18SF			170861	
20	080SP35SF			170865	
25	080SP35SF			170865	
30	077SP36SF			180554	
36	077SP36SF			180554	
Accessories Kit of two hinges for types from 12 to 36 holes.				080KCSP	170883

The catalogue numbers in **bold** are available from stock.

Dimensional drawings

Push-buttons

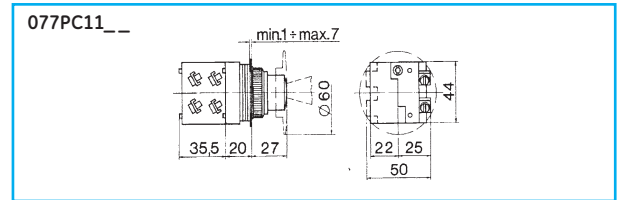
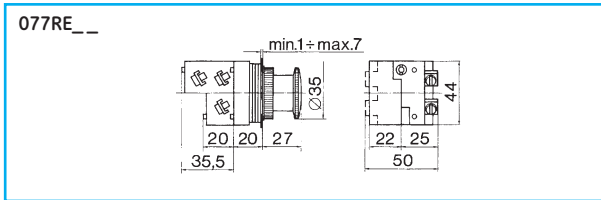
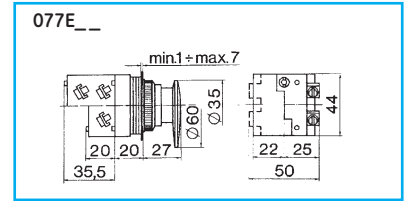
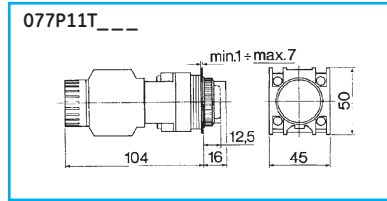
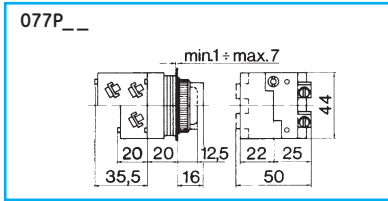

Selector switches

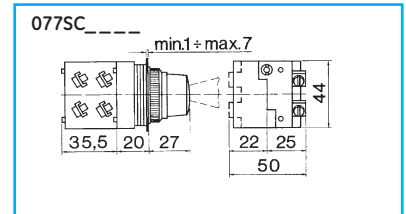
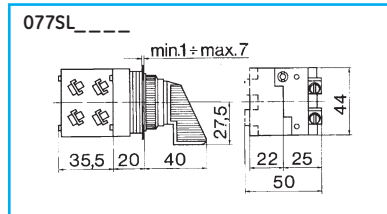
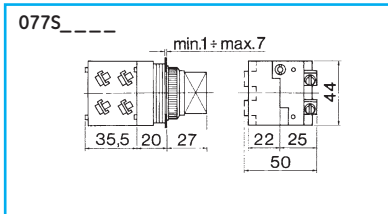

Joysticks

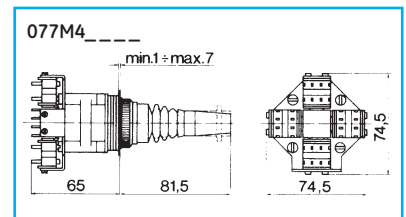
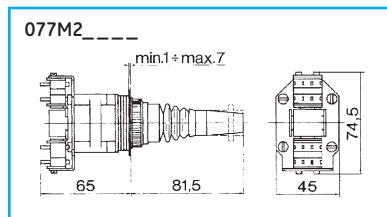
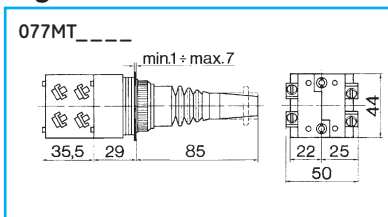

Illuminated push-buttons

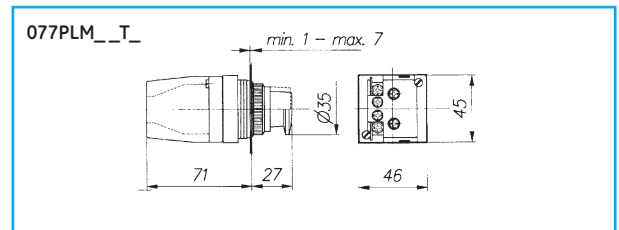
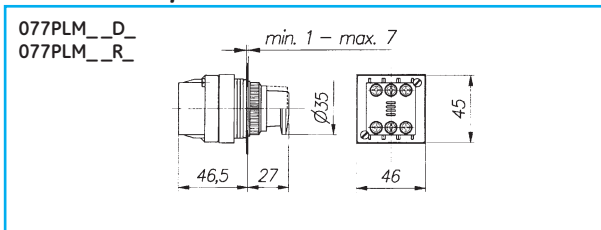

Illuminated selector switches

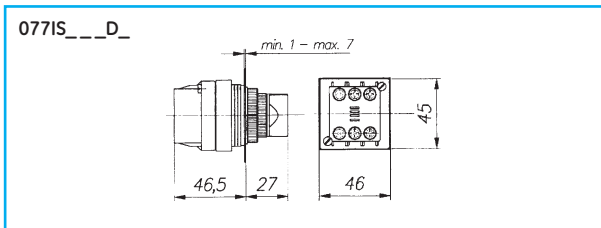

Pilot lights

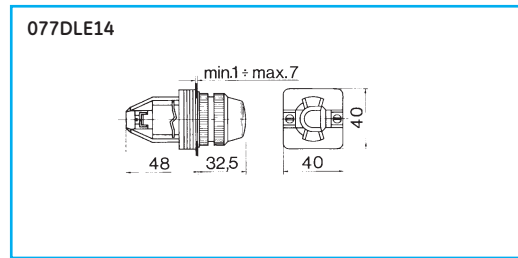
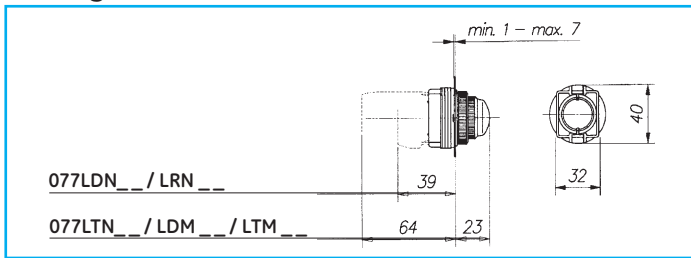

Kits

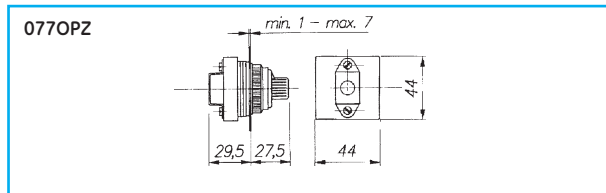
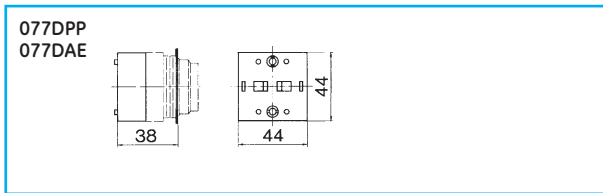

Nameplates

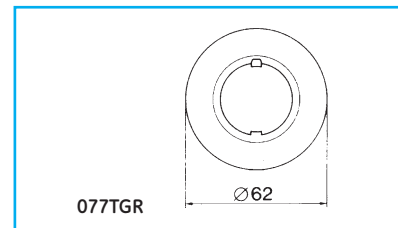
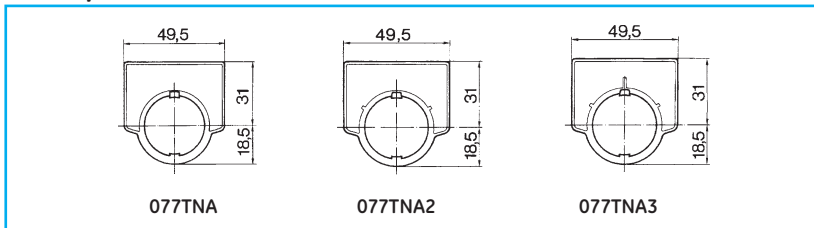

Contact blocks

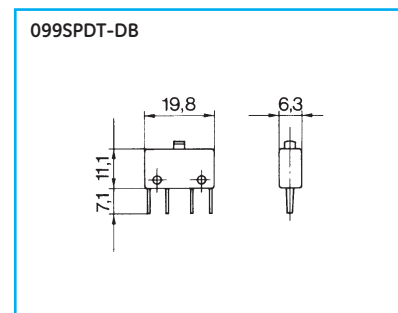
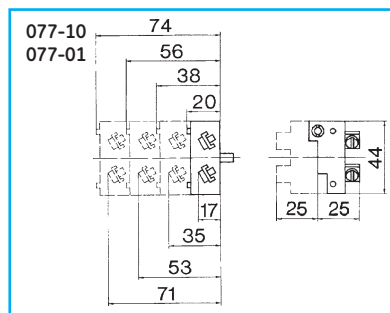
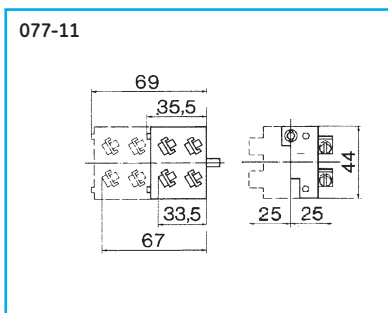

A
B
C
D
E
F
G
H
I
X

Dimensional drawings

Aluminium enclosures

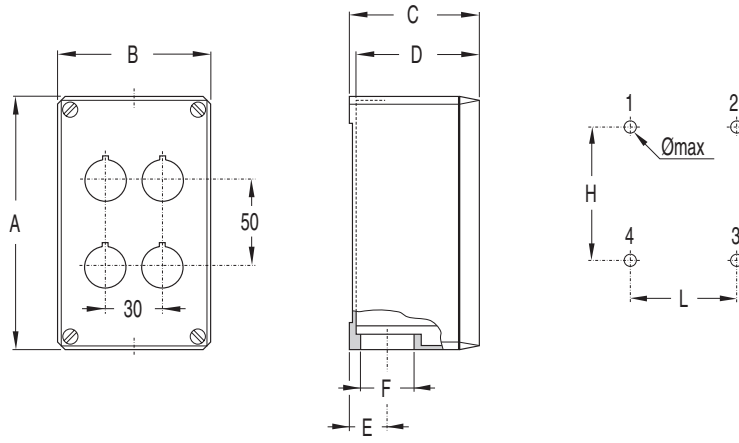

Type	Number of holes Ø 30		Dimensions						Fixing templates	
	Vertic.	Horizont.	A (mm)	B (mm)	C (mm)	D (mm)	E (mm)	F	HxLxØmax (mm)	position of the holes
1	-	-	87	87	75	72	21.5	PG 21	74x55x4	1 - 3
1M	-	-	87	87	100	97	21.5	PG 21	68x55x4	1 - 3
2	2	-	145	87	75	72	21.5	PG 21	132x55x4	1 - 3
2M	2	-	145	87	100	97	21.5	PG 21	126x55x4	1 - 3
3	3	-	195	87	100	97	21.5	PG 21	176x55x4	1 - 3
4V	4	-	257	92	86.5	83.5	23	PG 21	224x76x6	1 - 3
4	2	2	152	152	101.5	98.5	27	PG 29	136x119x6	1 - 3
6	2	3	205	230	101.5	98.5	27	PG 29	172x214x6	1-2-3-4
9	3	3	205	230	101.5	98.5	27	PG 29	172x214x6	1-2-3-4
12	3	4	257	300	101.5	98.5	35	PG 36	221x282x6	1-2-3-4
16	4	4	257	300	101.5	98.5	35	PG 36	221x282x6	1-2-3-4
20	5	4	350	350	123.5	106.5	41	PG 36	180x180x10	1-2-3-4
25	5	5	350	350	123.5	106.5	41	PG 36	180x180x10	1-2-3-4
30	6	5	410	410	144.5	127.5	53	PG 48	180x180x10	1-2-3-4
36	6	6	410	410	144.5	127.5	53	PG 48	180x180x10	1-2-3-4

Control and signalling units

A

B

C

D

E

F

G

H

I

X



Notes

Grid area for notes.

Control and signalling units Ø 30 mm

- A
- B
- C
- D
- E
- F
- G
- H
- I
- X





Light towers

- Outstanding modular concept. One terminal unit can be combined with **up to seven modular signal units**.
- Steady light units, flashing light units, strobe light units, LED light units.
- The buzzer elements emit a clearly audible dual-tone signal for maximum safety.
- A bayonet mounting, through a simple manual operation, allows a quick and simultaneous method of joining the signal units together and the electrical connection of them.
- Compact dimension Ø70mm.
- IP65 for use in extreme conditions.
- Captive screw cable connectors, located with terminal unit are **easy** to reach and guarantee a quick and neat electrical connection.
- The special design makes maintenance quick, easy and carried out in complete safety and without tools.
- The high quality of materials used to manufacture the lenses ensures the light output is at the **highest luminous** intensity, combined with a sturdy construction and a good resistance to aging.

Marking



Meaning of optical signals

	Colour	Meaning	Operating state
	Red	Extreme danger Hazardous conditions	Immediate action necessary
	Yellow / Amber	Beware Warning conditions imminent	Abnormal state Monitor or action as necessary
	Green	Normal conditions	No actions required
	Blue	Conditions requiring defined action	Discontinuity Intervention mandatory
	White / Clear	No particular meaning	Other state Can be used as required

Meaning of audible signals (EN 981, IEC 73)

	Signal tone	Meaning	Operating state
	Intermittent modulated tone	Danger	Immediate action necessary
	Linear tone	Safety	No actions required

Light units

NLT1... **Steady light unit**

- With socket BA15D for filament bulbs (7W max.) and LEDs
- Supply voltage: 240V AC/DC
- Current consumption (with 5W lamps):

24V	115V	240V
210mA	43mA	22mA



NLT2... **Flashing light unit**

- With socket BA15D for filament bulbs (7W max.) and LEDs
- Supply voltage: 24V AC/DC, 115V AC, 240V AC
- Current consumption (with 5W lamps):

24V DC	24V AC	115V AC	240V AC
130mA	145mA	25mA	15mA



NLT3... **Strobe light unit**

- Lamp type: 4 Joule xenon lamp
- Supply voltage: 24V AC/DC, 115V AC, 240V AC
- Current consumption:

24V DC	24V AC	115V AC	240V AC
75mA	135mA	20mA	15mA

- Flash frequency: 1,4Hz (84 flashes per min.) according with EN 60073



Audio units

NLT73BD **Pulsating tone**

- Protection degree IP54
- Tone: pulsating
- Audio frequency: 2900Hz
- Pulsating tone frequency: 0,5Hz according to EN 457
- Sound level at 1 m.: 90 dB (A)
- Supply voltage: 24V AC/DC
- Current consumption: 20mA



NLT75AJ - NLT75AN **Pulsating or constant tone**

- Protection degree IP54
- Tone: pulsating or constant
- Audio frequency: 2600Hz according to EN 457
- Pulsating tone frequency: 1Hz according to EN 457
- Sound level at 1 m.: pulsating tone: 95 dB (A) constant tone: 93 dB (A)
- Supply voltage: 115VAC (NLT75AJ) / 240VAC (NLT75AN)
- Current consumption:

115VAC	240VAC
40mA	30mA

Pulsating or constant tone, adjustable by removing or inserting bridge JP1 in the printed circuit.



NLT75BD **Modulated tone**

- Protection degree IP54
- Audio frequency: 2500 - 2800Hz according to EN 457
- Sound level at 1 m.: max. 90 dB (A)
- Supply voltage: 24V AC/DC
- Current consumption: 40mA

16 sounds can be selected by means of the dip switch



NLT77BD **Pulsating tone**

- Protection degree IP65
- Audio frequency: 1200 - 2600Hz according to EN 457
- Sound level at 1 m.: max. 84 dB (A)
- Supply voltage: 24V AC/DC
- Current consumption: 40mA



NLT77AJ - NLT77AN **Pulsating or constant tone**

- Protection degree IP65
- Tone: pulsating or constant
- Audio frequency: 2600Hz according to EN 457
- Pulsating tone frequency: 1Hz according to EN 457
- Sound level at 1 m.: pulsating tone: 78 dB (A) constant tone: 75 dB (A)
- Supply voltage: 115VAC (NLT77AJ) / 240VAC (NLT77AN)
- Current consumption:

115VAC	240VAC
40mA	30mA

Pulsating or constant tone, adjustable by removing or inserting bridge JP1 in the printed circuit.



A

B

C

D

E

F

G

H

I

X



Light units

Control and signalling units

A

B

C

D

E

F

G

H



I

X

	Supply voltage	Red		Amber		Yellow		Green		Blue		Clear	
		Cat. no.	Ref. no.	Cat. no.	Ref. no.	Cat. no.	Ref. no.	Cat. no.	Ref. no.	Cat. no.	Ref. no.	Cat. no.	Ref. no. Pack
Steady light units (bulb not included) 	12...240V	NLT1R	222230	NLT1A	222231	NLT1G	222232	NLT1V	222233	NLT1L	222234	NLT1I	222235 1
Flashing light units (bulb BA15D filament) (bulb included) 	24V AC/DC	NLT2BDR	222236	NLT2BDA	222237	NLT2BDG	222238	NLT2BDV	222239	NLT2BDL	222240	NLT2BDI	222241 1
	115V AC	NLT2AJR	222242	NLT2AJA	222243	NLT2AJG	222244	NLT2AJV	222245	NLT2AJL	222246	NLT2AJI	222247 1
	240V AC	NLT2ANR	222248	NLT2ANA	222249	NLT2ANG	222250	NLT2ANV	222251	NLT2ANL	222252	NLT2ANI	222253 1
Flashing light units (bulb LED) (bulb included) 	24V AC/DC	NLT2BDLR	222289	NLT2BDLA	222290	NLT2BDLG	222291	NLT2BDLV	222292	NLT2BDLL	222293	NLT2BDLI	222294 1
	115V AC	NLT2AJLR	222295	NLT2AJLA	222296	NLT2AJLG	222297	NLT2AJLV	222298	NLT2AJLL	222299	NLT2AJLI	242464 1
	240V AC	NLT2ANLR	222301	NLT2ANLA	222302	NLT2ANLG	222303	NLT2ANLV	222304	NLT2ANLL	222305	NLT2ANLI	222306 1
Strobe light units (bulb included) 	24V AC/DC	NLT3BDR	222254	NLT3BDA	222255	NLT3BDG	222256	NLT3BDV	222257	NLT3BDL	222258	NLT3BDI	222259 1
	115V AC	NLT3AJR	222260	NLT3AJA	222261	NLT3AJG	222262	NLT3AJV	222263	NLT3AJL	222264	NLT3AJI	222265 1
	240V AC	NLT3ANR	222266	NLT3ANA	222267	NLT3ANG	222268	NLT3ANV	222269	NLT3ANL	222270	NLT3ANI	222271 1



Audio units

	Protection degree	Supply voltage	Cat. no.	Ref. no.	Pack
 <p>Pulsating tone</p>	IP54	24V AC/DC	NLT73BD	222278	1
	IP65	24V AC/DC	NLT77BD	222279	1
 <p>Pulsating or constant tone Adjustable by removing or inserting bridge JP1 in the printed circuit</p>	IP54	115V AC	NLT75AJ	222287	1
		240V AC	NLT75AN	222288	1
	IP65	115V AC	NLT77AJ	222280	1
		240V AC	NLT77AN	222281	1
 <p>Modulated tone 16 sounds can be selected by means of dip switch</p>	IP54	24V AC/DC	NLT75BD	222286	1

The audio units can only be mounted as final top unit (top cover included)

Bulbs

	Supply voltage	Red		Amber		Yellow		Green		Blue		White		Pack		
		Cat. no.	Ref. no.	Cat. no.	Ref. no.	Cat. no.	Ref. no.	Cat. no.	Ref. no.	Cat. no.	Ref. no.	Cat. no.	Ref. no.			
 <p>LED - BA15D</p>	24V AC/DC	BA15D24LR	222330	BA15D24LA	222331	BA15D24LG	222332	BA15D24LV	222333	BA15D24LL	222334	BA15D24LB	222335	1		
	115V AC	BA15D115LR	222336	BA15D115LA	222337	BA15D115LG	222338	BA15D115LV	222339	BA15D115LL	222340	BA15D115LB	222341	1		
	240V AC	BA15D230LR	222342	BA15D230LA	222343	BA15D230LG	222344	BA15D230LV	222345	BA15D230LL	222346	BA15D230LB	222347	1		
<p>Incandescent BA15D</p>	Supply voltage													Clear		
	12V													BA15D125	222348	5
	24V													BA15D245	222349	5
	30V													BA15D305	222350	5
	115V													BA15D1155	222351	5
	240V													BA15D2305	222352	5

Terminal

	Cat. no.	Ref. no.	Pack
 <p>Terminal unit with top cover</p>	NLT9TC	222282	1

Base with tube

	Cat. no.	Ref. no.	Pack
 <p>Base + tube height 100mm</p>	NLT5BT	222284	1
Base + tube height 100mm, 90° fixing	NLT90BT	222307	1
Tube height extension 100mm	NLT5ET	222285	1

A

B

C

D

E

F

G

H

I

X



Technical data

Conformity to standards	EEC regulation 89/336 electromagnetic compatibility EEC regulation 73/23 low voltage, including amendment EEC 93/68 All NLT range are made and tested in full compliance with: EN 60947-5-14 (VDE 0470, IEC 60947) CE, cUL US
Materials	Polycarbonate Visual and audio signal units, terminal unit, top cover, base and extension tubes
Rated insulated voltage	250V max.
Operating temperature	-20°C ... +60°C (except version with bulb 12V = 40°C)
Protection degree (according to EN 60529)	IP65 (IP54 for audio units types NLT73xx and NLT75xx) (indicators must be correctly assembled with top cover, gasket or PG conduit fitting)
Colours (according to EN 60073)	Amber, Blue, Yellow, Clear, Red and Green
Lamp type	Steady/flashing units: Bayonet type BA15D socket: filament (7W max.) or LED Strobe units: Xenon lamps
Nr. of combined units	Up to 7 modular units
Connection	Captive screw cable connectors (max. cable size 1.5mm ²) inside terminal sleeve «C» is common to all signal units.
Connection identification code	They are numbered 1/7 from base to top

Mechanical characteristics

Mounting of the units	
Average torque	2.4Nm
Unfastening of the units	
Average torque	2.3Nm
Vibration resistance	2g min. (10-150Hz) according to IEC 68-2-6
Mounting	Direct through terminal unit or with base and tube

Dimensions

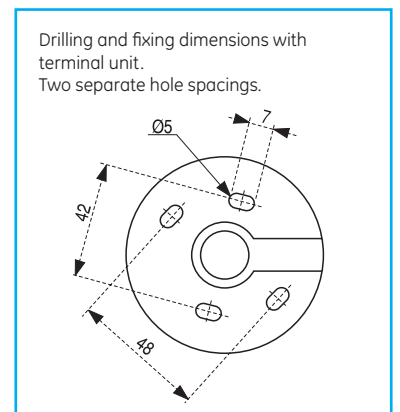
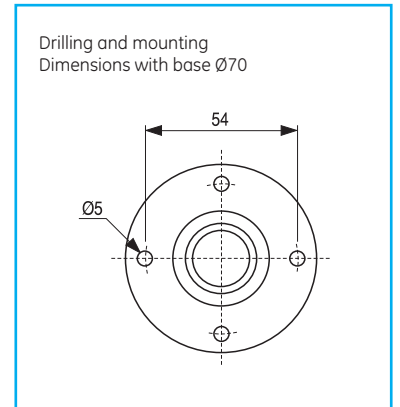
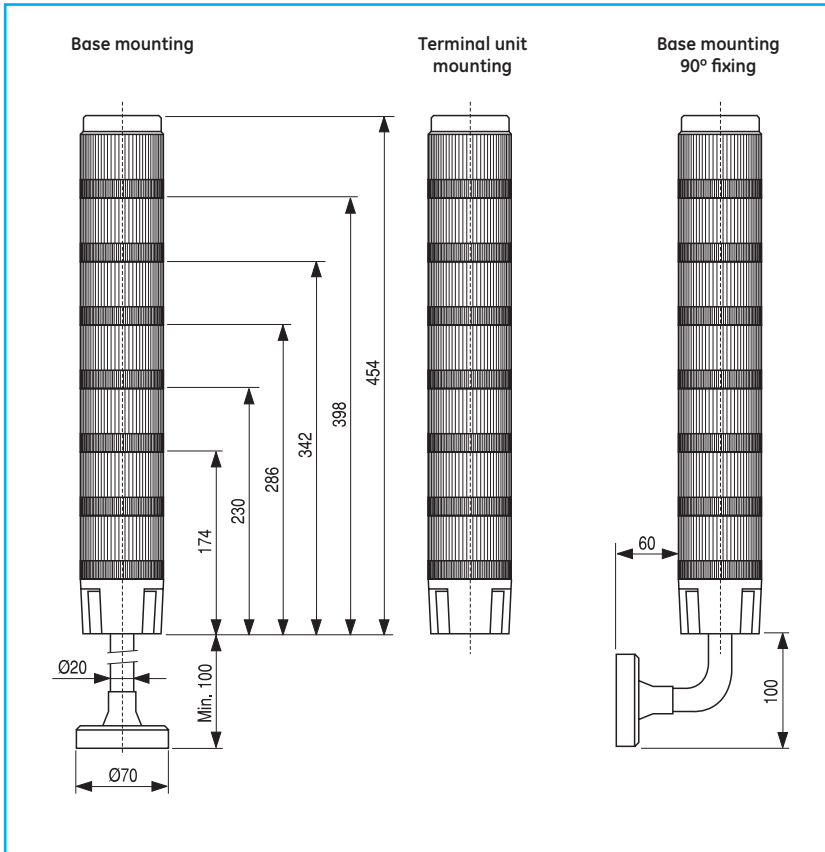

Modular system

Place signal beacon unit onto terminal unit **(1)** align guide marks and twist clockwise till they are locked **(2) + (3)**

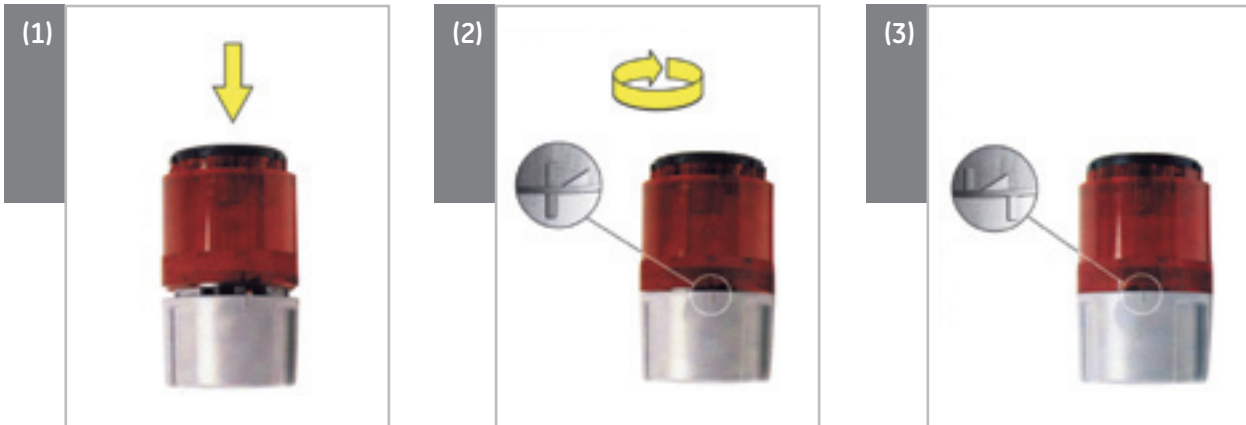

Follow the same steps to add more signal units **(4) + (5) + (6)**

The audible element can be mounted as final top unit, as it is complete with a top cover.

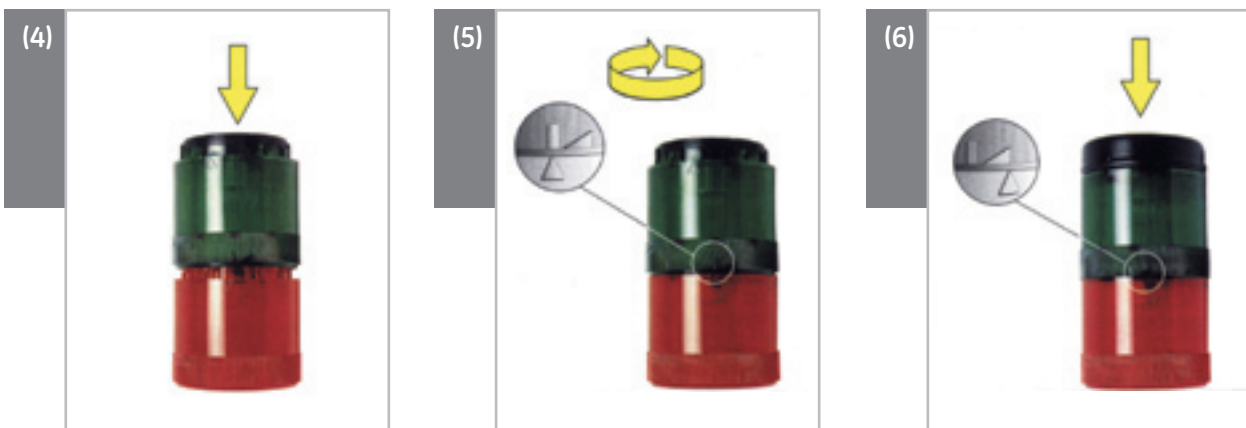

To fix extension tube (base always included), insert it into opening on the underside of the terminal unit and tighten screw on the side **(7)**. To reach the screw cable clamp terminals, remove black disc first, prising with a small screwdriver **(8)**. Connect to terminals (coloured units are numbered from base to top). To place terminal back into position, align the guiding marks **(9)** and press inwards.

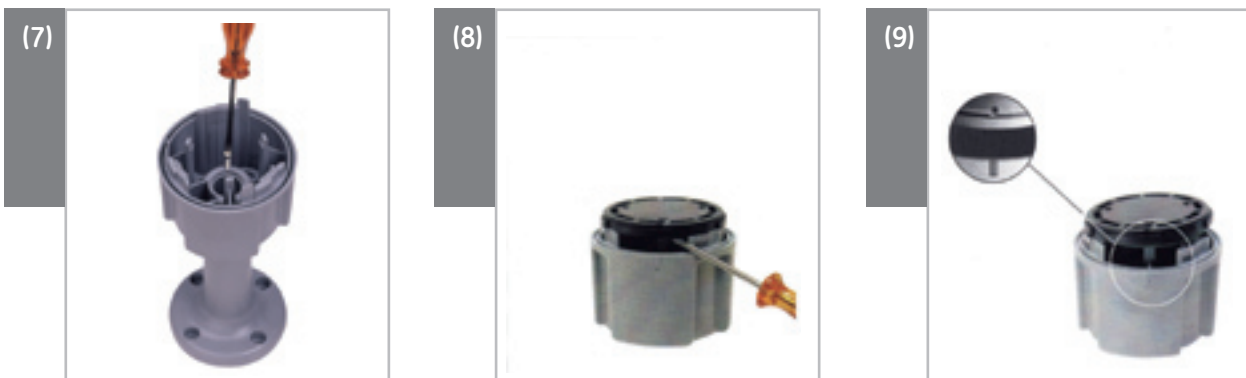

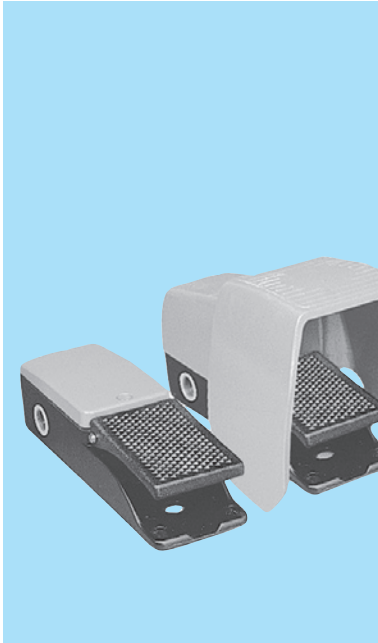

Foot switches

General

Foot switches, for intensive services suitable for controlling and monitoring of low voltage AC and DC electrical circuits.

Climatic protections

The standard versions are suitable for use in the following climates:

- Temperate climate cat. 23/50 (DIN 50014)
- Wet climate cat. 23/83 (DIN 50015)
- Hot wet climate cat. 40/92 (DIN 50015)
- Variable wet climate cat. FW 24 (DIN 50016)

Standards

IEC 947-5-1, CEI EN 60947.5.1
VDE 0660

Approvals

CSA, UL

Specifications

Temperature ranges	Operation	from -30°C up to +80°C						
	Storage	from -30°C up to +80°C						
Degree of protection (according to IEC 529)		IP 65						
Vibration resistance		20g (10 up to 55Hz)						
Mechanical endurance		2 x 10 ⁷ for all the types						
Electrical								
Rated insulation voltage according to EN 60947.1		500V						
Insulation class according to VDE 0110		Group C						
Electric shock protection according to IEC 536		Class I						
Short-circuit prot. according to IEC 269.1 and 269.3		10A gL fuses						
Electrical performances of the contact blocks								
Rated thermal current (I _{th})		10A						
Performances according to EN 60947.5.1								
	Slow motion contacts	Voltage	Ue (V)	24	48	110	220	380
	Category AC 15	Current	Ie (A)	6	6	6	6	4
	Snap action contacts	Voltage	Ue (V)	24	48	110	220	380
	Category AC 15	Current	Ie (A)	6	6	6	5	4
	Category DC 13	Voltage	Ue (V)	24	48	110	220	
		Current	Ie (A)	1	0,8	0,7	0,3	
Connection		Same polarity for both slow motion and snap action contacts						
Cables entries	IPA1, IPA2, IPB1, IPB2	1 x M20						
	IPA1-P	2 x M20						

Order codes ● pg. E.67
Dimensional drawings ● pg. E.73

Foot switches - Contact combinations (per pedal)

		Slow break				Snap action					
	Function (1)	Cat. no	Ref. no.	Cat. no	Ref. no.	Cat. no	Ref. no.	Cat. no	Ref. no.	Pack	
	ONE pedal Without guard	N	IPA1-N211B	132170		IPA1-N411B	132198	IPA1-N422B	132213	1	
		P(2)	IPA1-P211B	132171		-		-		1	
		D	-					IPA1-D422B	132214	1	
	ONE pedal With guard	N	IPB1-N211B	132172	IPB1-N222B	132186	IPB1-N411B	132201	IPB1-N422B	132215	1
		P(2)	IPB1-P211B	132173	-		-	-		1	
		D	-				-	IPB1-D422B	132216	1	
		R	-		-		IPB1-R411B	132203	-	1	
	ONE pedal With guard Heavy duty	N	IPA2-N211B	132182						1	
Spare microswitches		N211B	116113	N222B	116664	N411B	116663	N422B	116665	1	

- (1) **Function N**
Normal operation. When the pedal is pressed the contacts change position. When released they return to their position.
- Function P**
Press-on press-off operation. The position of the contacts changes each time the pedal is pressed.
- Function D**
Two-stage operation. Used with two contacts blocks. When the pedal is pressed to the first point, the contacts of the first block switch; when pressed as far as the second point the contacts of the second block switch and the first block stays in the same position.
- Function R**
Normal operation with potentiometer. When the pedal is pressed, the contacts change position at the same time as the potentiometer is operated. When released, the contacts and potentiometer return to their initial position.

Positive opening.

(2) Version with function P do not correspond to the concept of positive opening.



Approvals



Features

Enclosed in metal with aluminium protection cover, safety latch function "OFF-ON-OFF" with manual reset.

Technical data

Switching diagram	
1) Trigger point	1)
2) Latched position	2)
Rated insulation voltage U_i	max. 400VAC
Thermal continuous current I_{the}	max. 10A
Switching frequency	max. 50/min.
Mechanical operational life number of switching cycles	10×10^6
Ambient temperature	-30°C to +80°C
Cable conduits	(3x) M20x1.5
Protection degree	IP65
Actuating force (approx.)	10N
Trigger point	200N
Weight	1.5 kg

Safety foot switches

Operation

- 1 Pedal operation up to the trigger point**
The operating contact is closed, the operating process is started
- 2 Operation past the trigger point in emergency cases**
The operating contact is opened and latched and the process is stopped. Also if the device is unused, the latch remains in the off-position in this phase. Uncontrolled restart is prevented
- 3 Reset function**
Only after the danger has passed can the contacts be manually unlatched (push-button on the side). The operating process can now be restarted by pushing the pedal up to the triggering point.

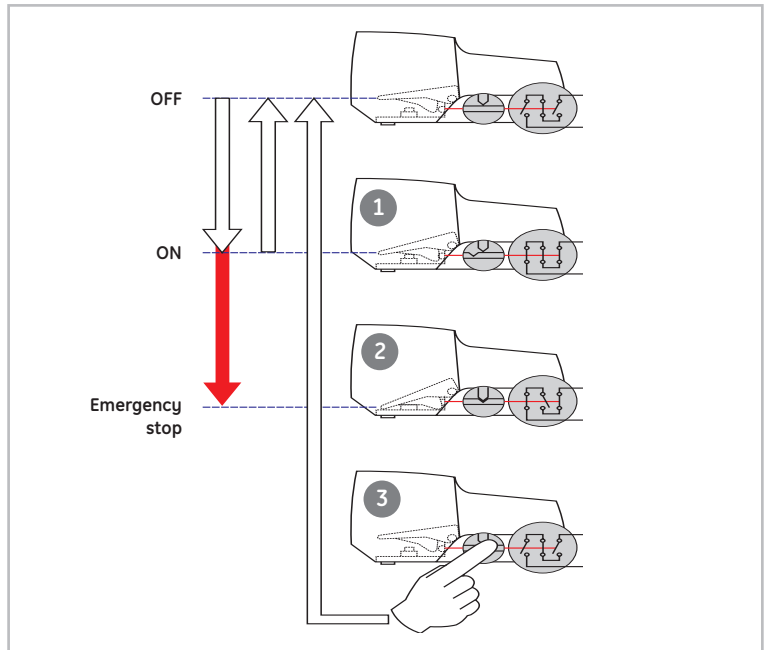

Order codes

	Cat. no.	Ref. no.	Pack
- According to standards: EN 60947-1 / IEC 60947-5-1	IPSF1	223000	1
- Slow-action contact			
- Snap-action contact			
- Trigger point			
- Latch function			
- Making current according to EN/IEC 60947-5-1 AC15/240V/3A			

Dimensions ● pg. E.73



Signalling devices

General

Series 105 signalling units are used to indicate the electric equipment power supply conditions.

For this purpose the devices shall be wired after the main disconnecting switch and clearly in view when the cabinet's doors are opened.

Series 105 DTL devices can be used on three-phase lines with or without the neutral wire or single-phase power lines, indicating the hazardous condition due to the applied voltage.

Three luminous red lamps are used. The flashing devices are normally used in combination with limit switches contacts NC type 114FCT03 that provides insertion when the cabinet door are open only.

Climatic protection

The standard versions are suitable for use in the following climates:

- Temperate climate cat. 23/50 (DIN 50014)
- Wet climate cat. 23/83 (DIN 50015)
- Hot wet climate cat. 40/92 (DIN 50015)
- Variable wet climate cat. FW 24 (DIN 50016)



Standards

CEI, IEC, VDE, BSI and UTE

Approvals

UL, CSA, CE

Suggested connections

Indicates the presence of 3, 2 or 1 phase only by means of the relative lamp.

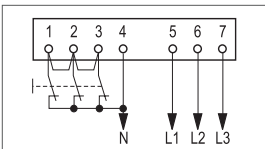

3-phase line with insulated neutral 3-phase line with grounded neutral

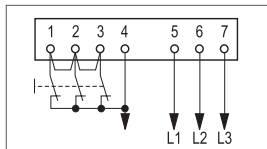

Indicates the presence of 3 or 2 phases by means of the relative lamp. One phase only is not indicated (all lamps OFF)

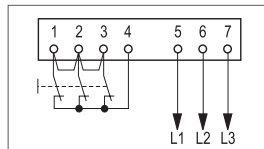

3-phase line without neutral

Indicates both phases with 3 lamps ON at same time. One phase only is not indicated (all lamps OFF)

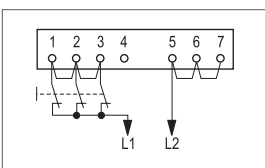

Single-phase line (general diagram)

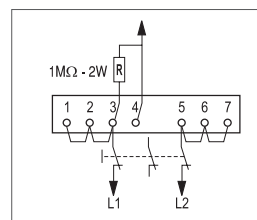

Single phase-line (alternative diagram)

1. Phase to phase connection on a 3 phase line with grounded neutral. Indicates the presence of 2-phases or 1 only with the 3 lamps ON at the same time.
2. Phase to neutral connection on a 3 phase line with grounded neutral or phase to phase by a matching transformer with one phase grounded. Indicates the presence of the ungrounded phase with the 3 lamps ON at the same time. No indication occur if the ungrounded phase is missing (all lamps OFF).

Specifications

Temperature ranges	Operation	from -25°C up to +70°C
	Storage	from -40°C up to +70°C
Degree of protection (according to IEC 529)		IP 20
Electrical		
Rated insulation voltage according to EN 60947.1		690V
Impulse withstand voltage according to EN 60947.1		4kV
Electrical input		2mA max.
Connections	Terminal strip with numbered terminals, accessible from outside	
	protected against accidental contacts according to DIN 57106 and IP 20 according to IEC 529	
Clamping capacity		Maximum one flexible conductor 12 AWG (3.3mm ²)

Order codes ● pg. E.70
Dimensional drawings ● pg. E.72



A

B

C

D

E

F

G

H

I

X

Flashing devices



Supply voltage		Cat. no	Ref. no.	Pack
Three-phase (50-60Hz)	Single-phase (50/60Hz)			
220V	110-127V	105DTL220	132230	1
380-600V	220-350V	105DTL500	132231	1
690V		105DTL690	132232	1

3 pole limit switch for device control



Protection degree	Cables entry	Operation force	Contacts	Cat. no	Ref. no.	Pack
IP40	PG11	8.5 N min.	3NC	114FCT03	130320	25
IP65	PG11	8.5 N min.	3NC	114FCT03T	130321	25

Paralell bridge for 3 poles limit switches



Cat. no	Ref. no.	Pack
105 PT	132234	50x5

Single door protection unit



The unit includes the following components:

- one flashing device 105DTL220 or 105DTL500.
- one 3-pole limit switch 114FCT03 for connection of the flashing device
- one electrical interlock device and panel light 105GIL or 105GIL10.
- one mounting plate 105PM on which are fitted on the above devices.

If two doors have to be protected (as double enclosure closing on the middle) the mounting plate shall be fitted also one limit switch 114FCT03 and one device 105GIL or 105GIL10.

Approvals:

UL (USA) - CSA (Canada)

Supply voltage			Cat. no	Ref. no.	Pack
Three-phase (50-60Hz)	Single-phase (50/60Hz)	Tripping coil			
220V	110-127V	Shunt trip	105GP1P220	132250	1
220V	110-127V	Undervoltage trip	105GP1P220M	132251	1
380-600V	220-350V	Shunt trip	105GP1P500	132252	1
380-600V	220-350V	Undervoltage trip	105GP1P500M	132253	1

Electrical interlock device and cubicle lighting ⁽¹⁾



The switch can be directly driven by the enclosure door.
If several doors are employed, one switch per door shall be used.
When properly connected, the following functions are provided:

- Position 1 (pushed) door closed: light OFF, tripping coil of main switch unpowered (normal equipment operation)
- Position 2. (free) door opening: light ON, tripping coil of main switch powered (equipment shall cut-out automatically).
- Position 3 (pulled) door open: light ON, tripping coil of main switch unpowered (adjustment on the equipment of dry checks). When door is closed again, the switch revert automatically from position 2 or 3 to position 1.

Terminals have IP2X protection degree according to IEC/EN 60529

Approvals: UL (U.S.A.) - CSA (Canada)

Tripping coil		Cat. no	Ref. no.	Pack																
Shunt trip		105 GIL	132240	1																
	<table border="1"> <thead> <tr> <th></th> <th>1</th> <th>2</th> <th>3</th> </tr> </thead> <tbody> <tr> <td>E</td> <td>○</td> <td>○</td> <td>○</td> </tr> <tr> <td>F</td> <td>○</td> <td>○</td> <td>○</td> </tr> <tr> <td>G</td> <td>○</td> <td>○</td> <td>○</td> </tr> </tbody> </table>		1	2	3	E	○	○	○	F	○	○	○	G	○	○	○			
	1	2	3																	
E	○	○	○																	
F	○	○	○																	
G	○	○	○																	
Undervoltage trip		105 GIL 10	132241	1																
	<table border="1"> <thead> <tr> <th></th> <th>1</th> <th>2</th> <th>3</th> </tr> </thead> <tbody> <tr> <td>E</td> <td>○</td> <td>○</td> <td>○</td> </tr> <tr> <td>F</td> <td>○</td> <td>○</td> <td>○</td> </tr> <tr> <td>G</td> <td>○</td> <td>○</td> <td>○</td> </tr> </tbody> </table>		1	2	3	E	○	○	○	F	○	○	○	G	○	○	○			
	1	2	3																	
E	○	○	○																	
F	○	○	○																	
G	○	○	○																	

Electrical interlock device ⁽¹⁾



The switch is directly driven by the enclosure door.
If several doors are employed, one switch per door is needed.
When properly connected, the same functions of devices above shall be provided but without enclosure control light.

Terminals have IP2X protection degree according to IEC 529

Tripping coil		Cat. no	Ref. no.	Pack								
Shunt trip		105 CI	132242	1								
	<table border="1"> <thead> <tr> <th></th> <th>1</th> <th>2</th> <th>3</th> </tr> </thead> <tbody> <tr> <td>G</td> <td>○</td> <td>○</td> <td>○</td> </tr> </tbody> </table>		1	2	3	G	○	○	○			
	1	2	3									
G	○	○	○									
Undervoltage trip		105 CI 10	132243	1								
	<table border="1"> <thead> <tr> <th></th> <th>1</th> <th>2</th> <th>3</th> </tr> </thead> <tbody> <tr> <td>G</td> <td>○</td> <td>○</td> <td>○</td> </tr> </tbody> </table>		1	2	3	G	○	○	○			
	1	2	3									
G	○	○	○									

Mounting plate



	Cat. no	Ref. no.	Pack
	105 PM	132244	1

(1) For electrical performance and features of contact blocks please see E.42

Dimensional drawings

Series 105 - Flashing devices

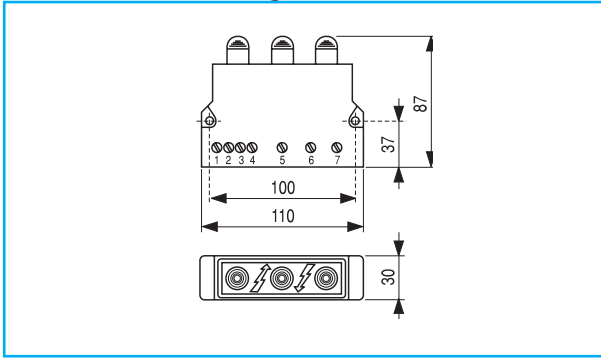

Series 105 - Single door protection unit

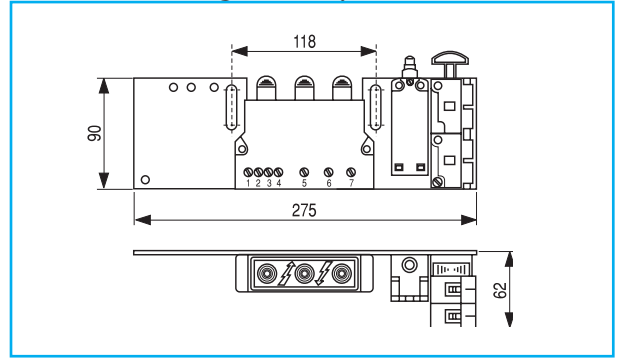

Series 105 - Electrical interlock and cubicle lighting

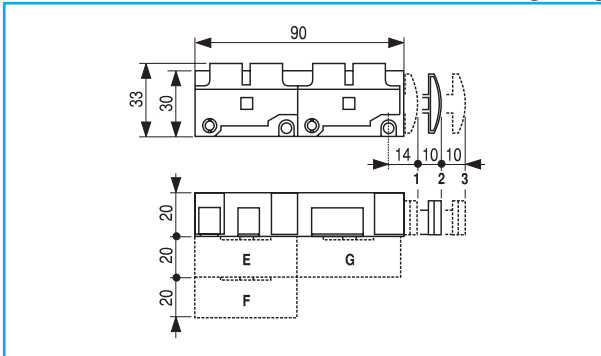

Series 105 - 3 pole limit switch for device control

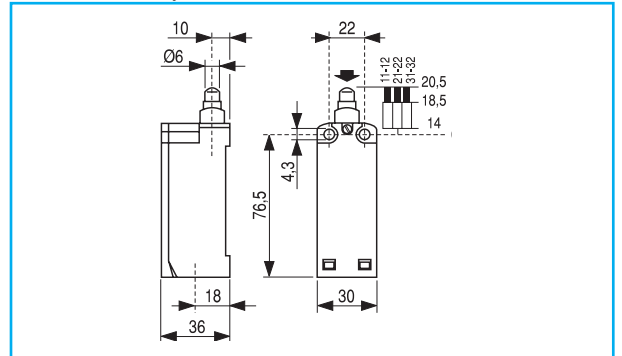

Series 105 - Electrical interlock device

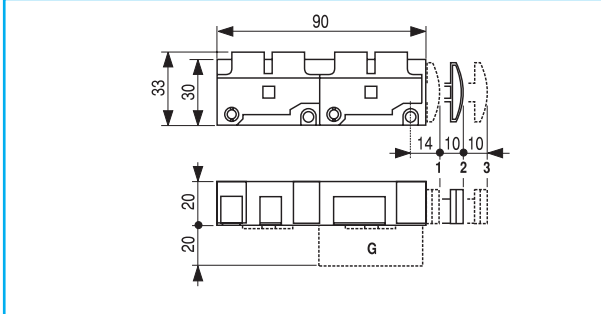

Series 105 - Mounting plate

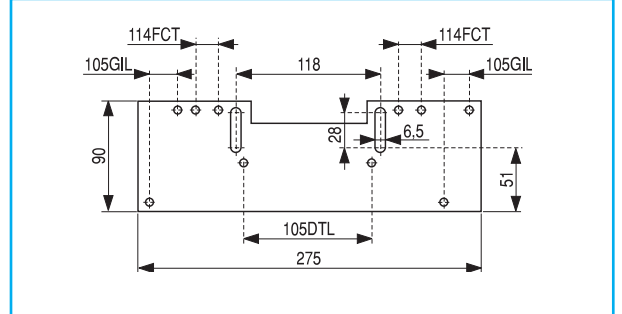

A

B

C

D

E

F

G

H

I

X

Series IP - Foot switches without protective guard

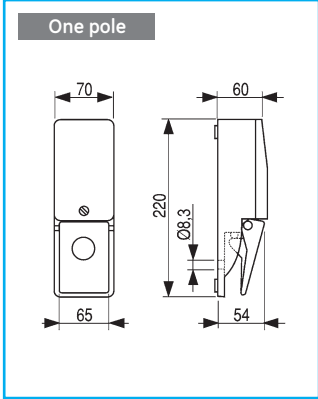

Series IP - Foot switches with protective guard

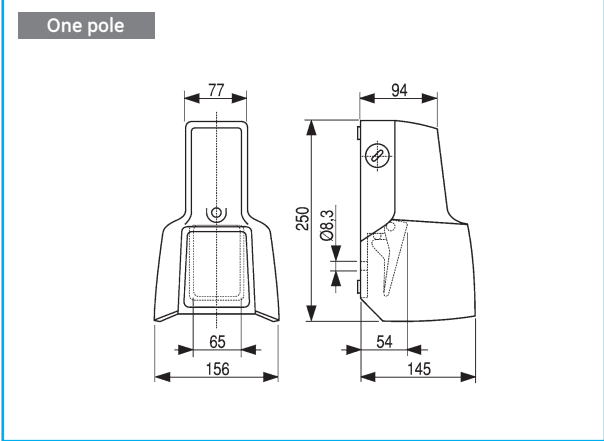

Safety foot switches

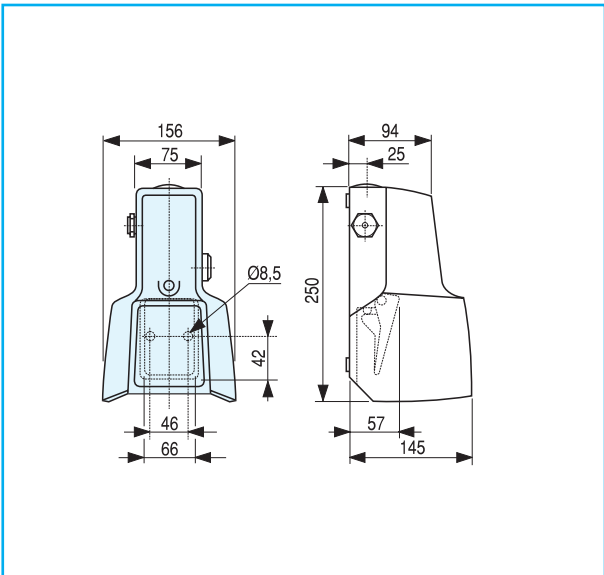

GE Consumer & Industrial Power Protection

Power Protection (formerly GE Power Controls), a division of GE Consumer & Industrial, is a first class European supplier of low-voltage products including wiring devices, residential and industrial electrical distribution components, automation products, enclosures and switchboards. Demand for the company's products comes from, wholesalers, installers, panel-board builders, contractors, OEMs and utilities worldwide.

www.ge.com/ex/powerprotection
www.ge.com/eu/powerprotection

GE POWER CONTROLS Ltd
Houghton Centre
Salhouse Road
Northampton NN4 7EX
United Kingdom

Customer Service
Tel. 0800 587 1251
Fax 0800 587 1239
E-mail: gepcuk@gepc.ge.com

GE CONSUMER & INDUSTRIAL HUNGARY
Váci út 77
H-1340 Budapest
Hungary

Customer Service
Tel. +361 447 6046
Fax +361 447 5060
E-mail: mea.export.consind@ge.com
Net: www.gepowershop.com

GE CONSUMER & INDUSTRIAL
POWER PROTECTION
Nieuwevaart 51
B-9000 Gent
Belgium

Tel. +32/9 265 21 11
Fax +32/9 265 28 00
E-mail: gepcbel@gepc.ge.com



GE imagination at work