

NS3550-2T-8S

NS3550-8T-2S

Industrial Gigabit Managed Switches



NS3550-2T-8S
8+2 Industrial Gigabit
Fiber Managed Switch

NS3550-8T-2S
8+2 Industrial Gigabit
Managed Switch

OVERVIEW

The IFS® Industrial Gigabit Managed Switches by Interlogix are fully managed Layer 2 switches providing an industrial hardened design. This design provides for operational recovery in the event of a network or power system failure.

The IFS NS3550-8T-2S is an Industrial Gigabit Managed Switch equipped with eight 10/100/1000Mbps RJ45 ports and two 100/1000Mbps SFP (fiber) uplink ports.

The IFS NS3550-2T-8S is an Industrial Gigabit Fiber Managed Switch equipped with eight 100/1000Mbps SFP (fiber) ports and two 10/100/1000Mbps RJ45 ports.

Layer 2 Managed Switch

The IFS Industrial Gigabit Managed Switch Series supports advanced features including IEEE 802.1Q VLAN, GVRP, port link aggregation, QoS, broadcast storm control and MAC address filtering. The series also includes IGMP snooping and querying multicasting for media operations and bandwidth utilization to fit a variety of applications. Via aggregation of supporting ports, the series allows the operation of high-speed trunk operation combining multiple ports. A maximum of four ports can be assigned for four trunk groups and support fail-over as well. Additionally, the IFS Industrial Gigabit Managed Switch Series is compatible with equipment from other vendors that meet IEEE 802.3 standards.

Industrial-grade Network Redundancy and Recovery

These switches not only incorporate the industry standard Rapid Spanning Tree Protocol (IEEE 802.1w RSTP), but also a rapid ring recovery protocol allowing improved network recovery times that are on average less than 20ms for redundant ring topologies. The switches incorporate a redundant power supply system to further enhance network reliability and uptime. Ideal for use in implementing highly fault-tolerant ring and mesh network architectures, these switches are well suited for harsh environments such as industrial security, factory automation and intelligent transportation systems (ITS).

Robust Hardened Design

With an IP-30 rated enclosure, IFS Industrial Gigabit Managed Switches provide a high level of immunity against electromagnetic (EMI) and radio-frequency (RFI) interference typically found in industrial environments. This series of switches comply with IEC60068-2-xx standards for free-fall, shock, and vibration and operate in -40°C~75°C temperatures found in difficult environments such as plant floors or in curbside traffic control cabinets.

STANDARD FEATURES

Physical Ports

- Auto MDI/MDI-X
- Auto-negotiation
- 1 RJ-45 console port

NS3550-2T-8S

- 8-ports SFP (fiber) 100/1000Base-X and 2-ports 10/100/1000Base-T

NS3550-8T-2S

- 8-port 10/100/1000Base-T and 2-ports SFP (fiber) 100/1000Base-X

Robust Hardened Design

- IP30 Aluminum metal case protection
- DIN-rail and Wall Mount Design
- 48V DC, redundant power with polarity reverse protect function
- Supports EFT protection 6000VDC for power line
- Supports 6000VDC Ethernet ESD protection
- -40°C~75°C operating temperature

Layer 2 Features

- Back pressure (Half-Duplex) and IEEE 802.3x PAUSE frame flow control (Full-Duplex)
- Store-and-Forward architecture and runt/CRC filtering
- Storm Control support
- Broadcast / Multicast / Unicast
- Supports **VLAN**
- IEEE 802.1Q Tagged VLAN
- Up to 255 VLANs groups, out of 4094 VLAN IDs
- Provider Bridging (VLAN Q-in-Q) support (IEEE 802.1ad)
- Private VLAN Edge (PVE)
- Protocol-Based VLAN
- MAC-Based VLAN
- Voice VLAN
- Supports **Spanning Tree Protocol**
- STP, IEEE 802.1D Spanning Tree Protocol
- RSTP, IEEE 802.1w Rapid Spanning Tree Protocol
- MSTP, IEEE 802.1s Multiple Spanning Tree Protocol, spanning tree by VLAN
- BPDU Guard
- Supports **Link Aggregation**
- 802.3ad Link Aggregation Control Protocol (LACP)
- Cisco ether-channel (Static Trunk)
- Maximum 5 trunk groups, up to 8 ports per trunk group
- Up to 16Gbps bandwidth (Duplex Mode)
- Provides Port Mirror (1-to-1)
- Port Mirroring to monitor the incoming or outgoing traffic on a particular port
- Loop protection

Quality of Service

- Ingress Shaper and Egress Rate Limit per port bandwidth control
- 8 priority queues on all switch ports
- Traffic classification
- IEEE 802.1p CoS
- IP TOS / DSCP / IP Precedence
- IP TCP/UDP port number
- Typical network application
- Strict priority and Weighted Round Robin (WRR) CoS policies
- Supports QoS and In/Out bandwidth control on each port
- Traffic-policing policies on the switch port
- DSCP remarking

Multicast

- Supports IGMP Snooping v1, v2 and v3
- Supports MLD Snooping v1 and v2
- Querier mode support
- IGMP Snooping port filtering
- MLD Snooping port filtering
- MVR (Multicast VLAN Registration)



Security



- IEEE 802.1x Port-Based / MAC-Based network access authentication
- Built-in RADIUS client to co-operate with the RADIUS servers
- TACACS+ login users access authentication
- RADIUS / TACACS+ users access authentication
- IP-Based Access Control List (ACL)
- MAC-Based Access Control List
- Source MAC / IP address binding
- DHCP Snooping to filter untrusted DHCP messages
- Dynamic ARP Inspection discards ARP packets with invalid MAC address to IP address binding
- IP Source Guard
- Auto DoS rule to defend DoS attack
- IP address access management

Management

- Switch Management Interfaces
- Console / Telnet Command Line Interface
- Web switch management
- SNMP v1 and v2c switch management
- SSH / SSL and SNMP v3 secure access
- Four RMON groups (history, statistics, alarms, and events)
- **IPv6** IP Address / NTP / DNS management
- Built-in Trivial File Transfer Protocol (TFTP) client
- BOOTP and DHCP for IP address assignment
- Firmware upload / download via HTTP / TFTP
- DHCP Relay
- DHCP Option 82
- User Privilege levels control
- NTP (Network Time Protocol)
- Link Layer Discovery Protocol (LLDP) Protocol
- Reset button for system reboot or reset to factory default

Industrial Gigabit Managed Switch Specifications

PART NO.		NS3550-2T-8S	NS3550-8T-2S
			
Physical Ports	10/100/1000Base-T Ports	RJ-45 (2)	RJ-45 (8)
	100/1000Base-X SFP Ports	SFP Ports (8)	SFP Ports (2)
	Port Configuration	Auto MDI/MDI-X	
	Port Speed	Auto-negotiate	
	Electro Static Discharge (ESD) Protection	6K VDC	
	Console Port	RJ-45 (1)	
Switch Performance	Switch Architecture	Store-and-Forward	
	Switch Fabric	20Gbps/non-blocking	
	Throughput (Packet per second)	14.8Mpps @64Bytes	
	Address Table	8K entries	
	Share Data Buffer	4Mbit	
	Maximum Frame Size	9K Bytes (Jumbo Frames)	
	Flow Control	Back pressure for Half-Duplex IEEE 802.3x Pause Frame for Full-Duplex	
Layer 2	Port Configuration	Port disable/enable, Auto-negotiation 10/1000/1000Mbps full and half-duplex mode selection, Flow control disable/enable and bandwidth control on each port	
	Port Status	Display each port's speed Auto negotiation status, duplex mode, link status, Flow control status	
	Bandwidth Control	Bandwidth control per port: Ingress: 500Kb~1000Mbps, Egress: 500Kb~1000Mbps	
	Spanning Tree	IEEE 802.1d Spanning Tree, IEEE 802.1w Rapid Spanning Tree, IEEE 802.1s Multiple spanning tree protocol	
	VLAN	802.1Q Tagged Based VLAN, up to 255 VLAN groups Q-in-Q tunneling Private VLAN Edge (PVE) MAC-Based VLAN Protocol-Based VLAN Voice VLAN MVR (Multicast VLAN Registration) Up to 255 VLAN groups, out of 4094 VLAN IDs	
	Multicast	IGMP (v1/v2/v3) Snooping, up to 255 multicast Groups IGMP Querier mode support MLD (v1/v2) Snooping, up to 255 multicast Groups MLD Querier mode support	
	QoS	Traffic classification based, Strict priority and WRR 8-Level priority for switching - Port Number - 802.1p priority - 802.1Q VLAN tag - DSCP/TOS field in IP Packet	
	Port Mirroring	RX / TX / Both	
	Security	IEEE 802.1x Port-Based / MAC-Based network access authentication. RADIUS / TACACS+ users access authentication. IP-Based Access Control List (ACL). MAC-Based Access Control List. Source MAC / IP address binding. DHCP Snooping. Dynamic ARP Inspection. IP Source Guard prevents IP spoofing attacks. Auto DoS rule to defend DoS attack. IP address access management	
	SNMP MIBs	RFC-1213 MIB-II, IF-MIB, RFC-1493 Bridge MIB, RFC-1643 Ethernet MIB, RFC-2863 Interface MIB, RFC-2665 Ether-Like MIB, RFC-2819 RMON MIB (Group 1, 2, 3 and 9), RFC-2737 Entity MIB, RFC-2618 RADIUS Client MIB, RFC-2933 IGMP-STD-MIB, RFC3411 SNMP-Frameworks-MIB, IEEE 802.1X PAE, LLDP, MAU-MIB	
	Link Aggregation	IEEE 802.3ad LACP / Static Trunk, Supports 5 groups of 8-Port trunk support	
	Management Interface	Console, Telenet, Web Browser, SNMP v1, v2c and v3	

PART NO.		NS3550-2T-8S	NS3500-8T-2S	
				
LED Status Indicators	System	Power 1 (Green), Power 2 (Green), Fault Alarm (Green), Ring (Green), Ring Owner (Green)		
	10/100/1000Mbps Ports	LNK/ACT (Green)		
	SFP GigE Uplink Ports	1000 (Orange), LNK/ACT (Green)		
Electrical & Mechanical	Power Input 1 (Primary Power)	12-48VDC or 24VAC		
	Power Input 2 (Primary Power)	12-48VDC or 24VAC		
	Electrical Fast Transient (EFT) Protection	6KV DC		
	Power and Alarm Fault Connector	6-pin removable screw terminal		
	Alarm Fault Relay	1A @ 24VDC		
	Enclosure	IP-30 Metal Case		
	Mounting	DIN-rail or wall-mount		
	Dimensions (in/cm) (W x D x H)	6 x 4.21 x 2.83 in. (152 x 107 x 72mm)	3.5 x 5.31 x 2.2 in. (88 x 135 x 56mm)	
	Weight (lbs/g)	2.28 lbs., 1036g	1.59 lbs., 720g	
Environmental	Operating Temperature	-40°C~75°C		
	Storage Temperature	-40°C~85°C		
	Relative Humidity	5%~95% (non-condensing)		
Standards Compliance	Regulatory Standards	FCC Part 15 Class A, CE		
	IEEE/RFC Standards	IEEE 802.3 10Base-T IEEE 802.3u 100Base-TX/100Base-FX IEEE 802.3z Gigabit SX/LX IEEE 802.3ab Gigabit 1000T IEEE 802.3x Flow Control and Back Pressure IEEE 802.1d Spanning Tree Protocol IEEE 802.1w Rapid Spanning Tree Protocol IEEE 802.1p Class of Service IEEE 802.1Q VLAN Tagging IEEE 802.1x Port Authentication Network Control RFC 768 UDP RFC 793 TFTP RFC 791 IP RFC 792 ICMP RFC 2068 HTTP RFC 1112 IGMP Version 1 RFC 2236 IGMP Version 2		
	IEC Standards	IEC60068-2-32 (Free fall) IEC60068-2-27 (Shock) IEC60068-2-6 (Vibration)		

Dimensional Diagrams

NS3550-2T-8S

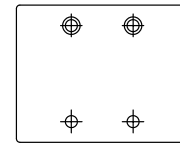
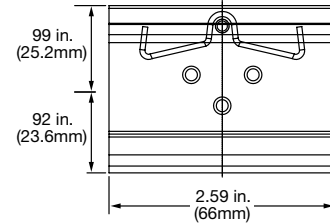
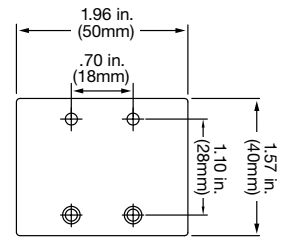
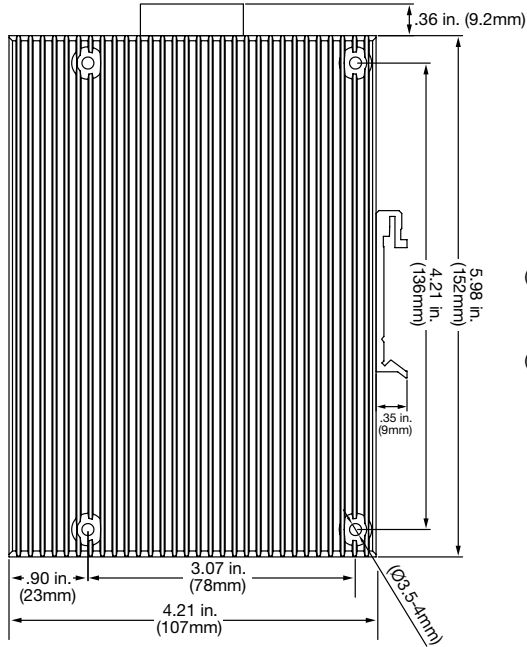
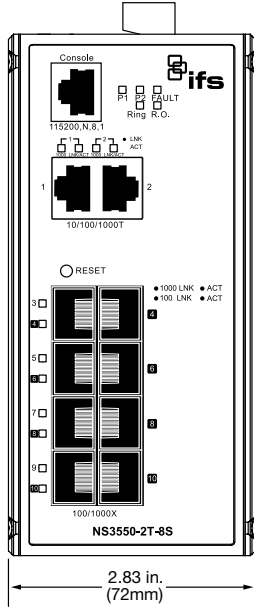

NS3550-8T-2S

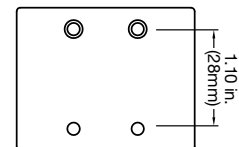
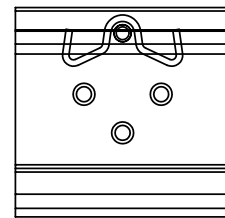
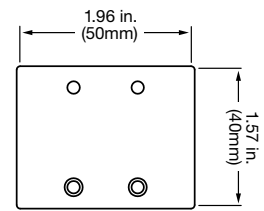
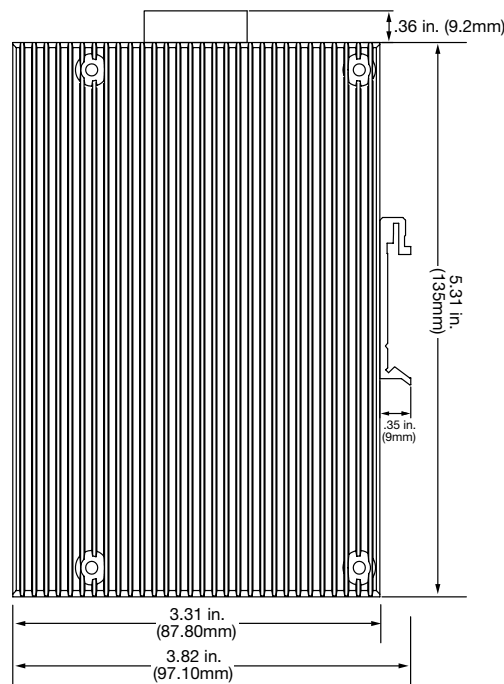
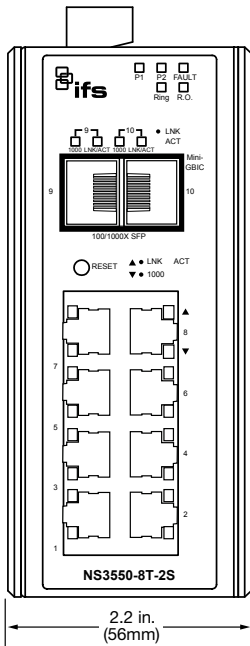

NS3550-2T-8S NS3550-8T-2S

Industrial Gigabit Managed Switches

Typical Application

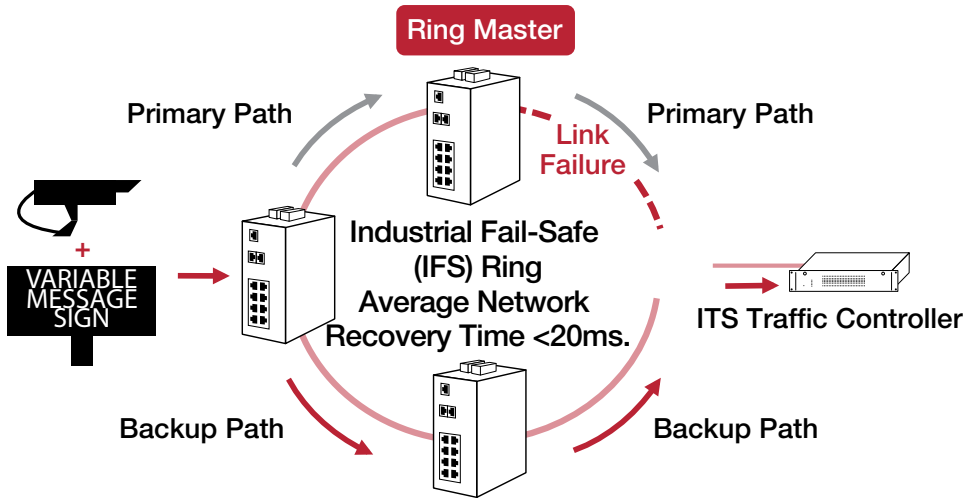

Ordering Information

NS3550-2T-8S	8-Port Industrial Gigabit Fiber Managed Switch (SFP) (Wide Operating Temp. -40°C~75°C)
NS3550-8T-2S	8-Port Industrial Gigabit Managed Switch (Wide Operating Temp. -40°C~75°C)
Included Accessories	User's Manual, DIN-rail Kit, Wall Mount Kit

Note: These switches require a Small Form-factor Pluggable (SFP) for optical uplink use. IFS SFPs are available for multi-mode, single mode, and 1 or 2 fibers for various transmission distances over optical fiber. Please refer to the IFS SFP data sheet to select the appropriate SFP for your particular application needs. IFS S25 or S35 Series SFPs are recommended.

Note: External power supply must be purchased separately.

Accessories

SFP	S30 Series
SFP	S35 Series (wide-temp)
SFP	S20 Series
SFP	S25 Series (wide-temp)
PS48VDC100W-DIN	48VDC Industrial 100W DIN-rail Power Supply (for NS3550-2T-8S or NS3550-8T-2S)



interlogix.com

Specifications subject to change without notice.

© 2016 United Technologies Corporation.

All rights reserved.

All trademarks are the property of their respective owners.

Interlogix is part of UTC Climate, Controls & Security,
a unit of United Technologies Corporation.

2016/11 (GSP-2111)