

3-Phase switched PDU + outlet measurement specification drawing

400V 16A / 32A PDU : C13 x 24 + C19 x 6

unit : mm

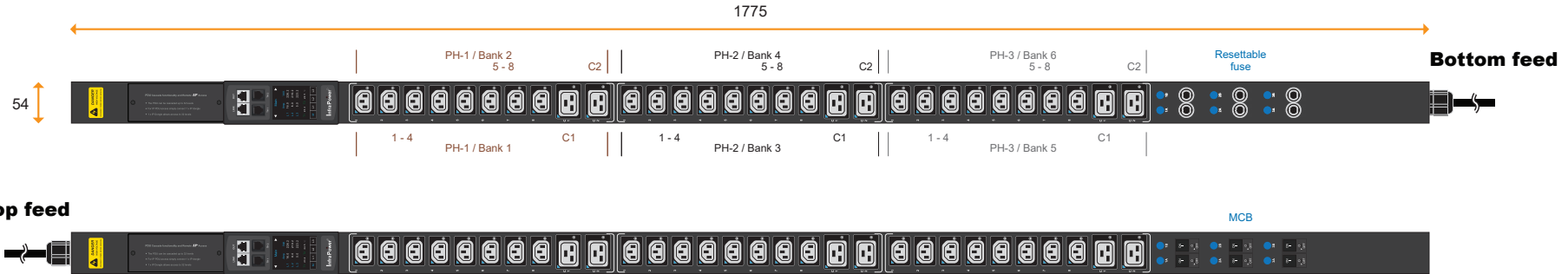

Circuit Protection	Code
Fuse	F
MCB	CR



32A model :	Circuit Protection
VP24C13/6C19-32A-WSi F _EN/2 B -1	Resettable Fuse x 6
VP24C13/6C19-32A-WSi CR _EN/2 T -1	1-pole MCB x 6

- Input Rating : 32Amp, 400V 3PH
- Cordset : 5-wire 2 meter 4mm sq. H05V V-F cordset
- Protection : 16A resettable fuse or 16A single pole hydraulic MCB x 6
- PH-1 - Bank 1 : Output 16A max., C13 #1-4 + C19 #C1
- Bank 2 : Output 16A max., C13 #5-8 + C19 #C2
- PH-2 - Bank 3 : Output 16A max., C13 #1-4 + C19 #C1
- Bank 4 : Output 16A max., C13 #5-8 + C19 #C2
- PH-3 - Bank 5 : Output 16A max., C13 #1-4 + C19 #C1
- Bank 6 : Output 16A max., C13 #5-8 + C19 #C2
- Weight : Net 12.20 Kg / Gross 14.20 Kg

PDU Feed	Code
Bottom	B
Top	T

Chassis Color	Code
Black	1
White	2
Red	3
Blue	4
Green	5
Orange	6
Yellow	7
Purple	8



16A model :	Circuit Protection
VP24C13/6C19-16A-WSi F _EN/2 B -1	Resettable Fuse x 3
VP24C13/6C19-16A-WSi CR _EN/2 T -1	1-pole MCB x 3

- Input Rating : 16Amp, 400V 3PH
- Cordset : 5-wire 2 meter 1.5mm sq. H05V V-F cordset
- Protection : 16A resettable fuse or 16A single pole hydraulic MCB x 3
- PH-1 : Output 16A max., C13 #1-8 + C19 #C1-C2
- PH-2 : Output 16A max., C13 #1-8 + C19 #C1-C2
- PH-3 : Output 16A max., C13 #1-8 + C19 #C1-C2
- Weight : Net 12.20 Kg / Gross 14.20 Kg

Standard color : Black

Operating Temperature : -5 to 60 °C
Storage Temperature : -25 to 65 °C
Operating Altitude : 0 to 2,000 m
Storage Altitude : 0 to 15,000 m
Humidity : 8 to 95% RH, non-condensing

Meter Features (WSi Switched PDU + Outlet Measurement)
Local Display : Field replaceable 2.8" color LCD with touchscreen
Bank Measurement : Current (A), Energy (kWh), Voltage (V) & Power factor
Outlet Measurement : Current (A), Energy (kWh)
Outlet Control : Outlet Switch ON / OFF
Accuracy : ±1% Billing-grade
IP Access : via IP dongle, one IP Access up to 32 PDU Levels
Cascade : Up to 32 PDU under single IP address via IP dongle
SNMP : V2 / V3 via IP dongle
Sensor Port x 2 : Temp. Sensor / Temp. + Humid. Sensor

EMC Compliance : CE / EMC
Safety Compliance : CE / LVD
Environment Compliance : RoHS3 & REACH

AUSTIN HUGHES
Design. Manufacturing. Global Services.

The company reserves the right to modify product specifications without prior notice and assumes no responsibility for any error which may appear in this publication.

Copyright 2021 Austin Hughes Electronics Ltd. All rights reserved.

IP dongle (option)
- Dual LAN Network Failover
- 10/100 Ethernet & Gigabit Ethernet standard
- Enterprise IP Authentication, LDAPV3 / LDAPS, Active Directory®, RADIUS protocol

Product Dimension : 54 (W) x 80 (D) x 1775 (H) mm
Packing dimension (for 2 PDUs) : 110 (W) x 268 (D) x 2043 (H) mm

Lockable IEC Outlet

- Patented design for InfraPower PDU



C13 Outlet



C19 Outlet

Lockable IEC Cable

- Patented design of InfraPower PDU
- Low cost, easy to lock & secure
- Proprietary for lockable IEC outlet
- Applicable to standard IEC outlet
- 6 colors & 3 lengths available
- Custom color & length on request
- VDE & ENEC approval

C13 - C14

H05VV-F 3G 0.75mm²

Cable Color	0.5M	1M	2M
Black	✓	✓	✓
Grey	✓	✓	✓
Red	✓	✓	✓
Blue	✓	✓	✓
Green	✓	✓	✓
Orange	✓	✓	✓



C19 - C20

H05VV-F 3G 1.5mm²

Cable Color	1M	2M
Black	✓	✓
Grey	✓	✓
Red	✓	✓
Blue	✓	✓
Green	✓	✓
Orange	✓	✓



C13 - C14



lockable cable

C19 - C20

- ✓ low cost
- ✓ easy to lock
- ✓ secure



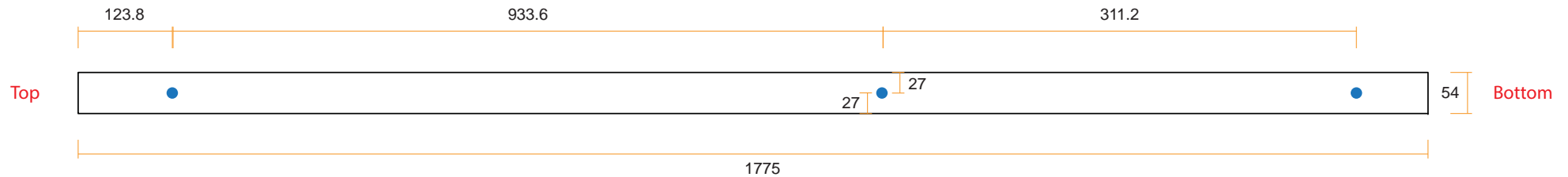
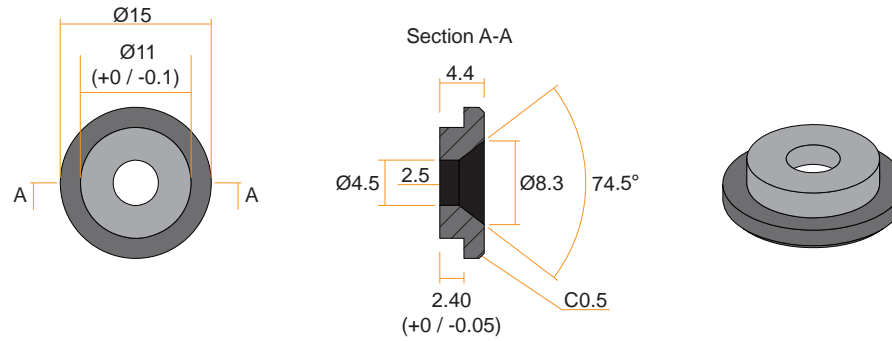

VMS Mounting Button

 x 3 +  x 3
M4 Screw
 - Flat head
 - M4x10mm
PEG



VMB Mounting Bracket

 x 4 +  x 2
M3.2 Screw
 - Flat head
 - M3.2x6mm
Bracket

